

# GT1790A

INSTRUCTION BOOK



COMPUTER-CONTROLLED HIGH SPEED LOCKSTITCH  
BUTTONHOLING MACHINE



**TYPICAL**

## Contents

I.	Important Safety Instructions.....	1
II.	Specifications.....	1
1.	Specifications.....	1
2.	List of standard sewing shapes.....	2
3.	Structure.....	3
III.	Installation.....	5
IV.	Operation Preparation.....	15
1.	Lubrication.....	15
2.	Attaching the needle.....	15
3.	Threading the needle thread.....	16
4.	Threading the bobbin case.....	16
5.	Adjusting bobbin thread tension.....	17
6.	Installing bobbin case.....	17
7.	Installing the knife.....	19
8.	Checking the delivery state.....	19
V.	Operation of the Sewing Machine.....	20
1.	Description operation panel switch.....	20
2.	Basic operation of the sewing machine.....	22
3.	Pedal operation method.....	23
4.	Inputting the presser type.....	25
5.	Selecting pattern.....	26
6.	Change needle thread tension.....	27
7.	Performing re-sewing.....	29
8.	Winding bobbin thread.....	31
9.	Using the counter.....	33
10.	Using the initial value management.....	35
11.	Changing sewing data.....	37
12.	Method of setting sewing data with/without edit.....	38
13.	Sewing data list.....	39
14.	Copying sewing data.....	45
15.	Edit/check the data other than sewing data.....	46
16.	Using parameter register key.....	48
17.	Performing continuous sewing.....	49
18.	Performing cycle sewing.....	52
19.	Change the name of cycle sewing/continuous sewing data.....	55
20.	Description of plural motions of knife.....	56
21.	Changing method of memory switch data.....	57
22.	List of memory switch data.....	58
23.	Adjusting pedal depression value.....	62
24.	Adjusting the contrast.....	63
25.	Setting the key lock.....	63
26.	Communication.....	64
VI.	Maintenance.....	66

1.	Adjusting the needle-to-hook relation.....	66
2.	Adjusting the needle thread trimmer.....	68
3.	Adjusting the presser bar pressure.....	69
4.	Adjusting the bobbin presser unit.....	69
5.	Thread tension.....	70
6.	Replacing the fuse.....	71
VII.	Standard Parts.....	72
1.	Cloth cutting knife.....	72
2.	Throat plate.....	72
3.	Presser.....	72
IX.	Trouble and Corrective Measures.....	79
X.	Table of Initial Value Data for Each Shape.....	81

## I. Important Safety Instructions

- 1) Never operate the sewing machine before adding lubricant into the oiling tank.
- 2) When operation is completed, please remove dust from the hook bobbin thread cutting knife and check whether the lubricant is sufficient.
- 3) Be sure to return the activating pedal to the home position after the machine has started to run.
- 4) A detector is installed so that this sewing machine cannot be operated in the state that the machine head is tilted. When operating the sewing machine, please turn on the power after correctly set the machine head on the table.

## II. Specifications

Main specifications for CSM-1790A Computer-controlled High-speed Lockstitch Buttonholing Machine

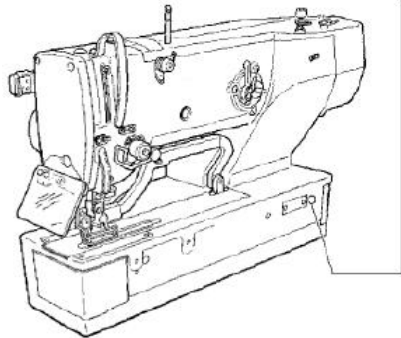
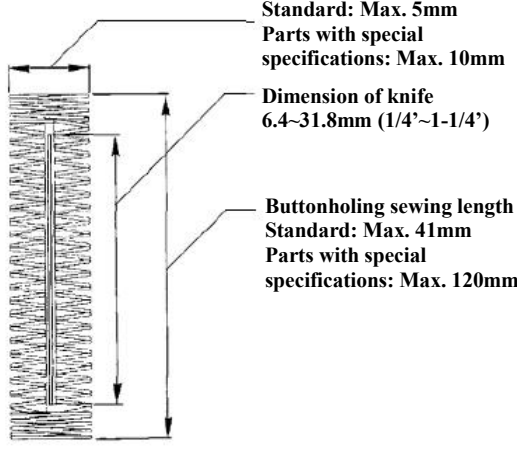
	Subclass	(S)
	Major application	Buttonholes on button cloth such as shirts, blouses, working uniforms, suit-dress.
	Buttonhole size	 <p>Standard: Max. 5mm Parts with special specifications: Max. 10mm</p> <p>Dimension of knife 6.4-31.8mm (1/4'-1-1/4')</p> <p>Buttonholing sewing length Standard: Max. 41mm Parts with special specifications: Max. 120mm</p>

### 1. Specifications

Sewing speed	Standard speed: 3600sti/min (Max.: 4200sti/min) (In case of dry-type hook, max.: 3300sti/min)
Needle	DPX5 # 11J ~# 14J
Hook	Full rotating hook, type DP
Needle rocking drive method	Driving pulse motor
Needle feeding drive method	Driving pulse motor
Presser lifting drive method	Driving pulse motor
Lift of presser foot	14mm (set as required) Max.: 17mm (in case of backstitch)
Cloth cutting knife drive method	Driving pulse motor
Number of standard sewing shapes	31 types
Number of memorized patterns	99
Power supply	Single phase 200/220/230/240V, 370VA

## 2. List of standard sewing shapes

- (1) Square type (2) Round type (3) Radial square type (4) Radial type (5) Radial straight bar-tacking type (6) Radial taper bar-tacking type (7) Eyelet square type

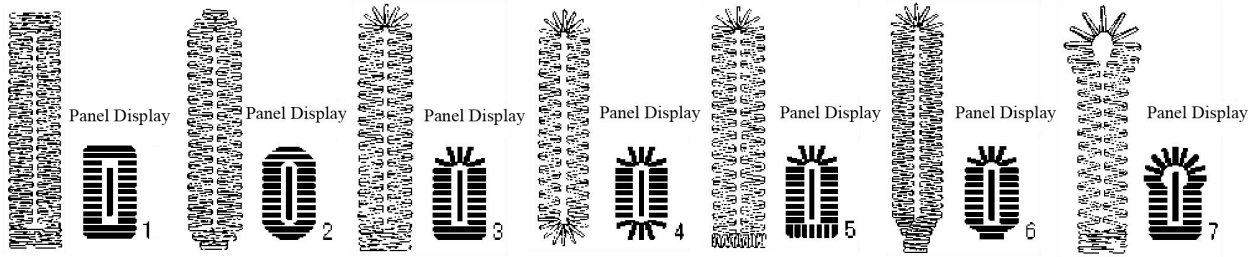

- (8) Eyelet radial type (9) Eyelet straight bar-tacking type (10) Eyelet taper bar-tacking type (11) Semilunar type (12) Round square type (13) Semilunar square type (14) Semilunar straight bar-tacking type

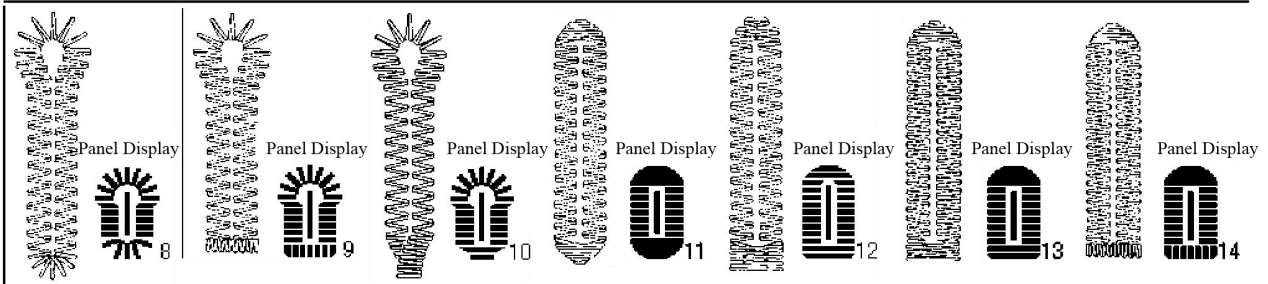

- (15) Semilunar taper bar-tacking type (16) Eyelet semilunar type (17) Eyelet round type (18) Square radial type (19) Square semilunar type (20) Square round type (21) Square straight bar-tacking type

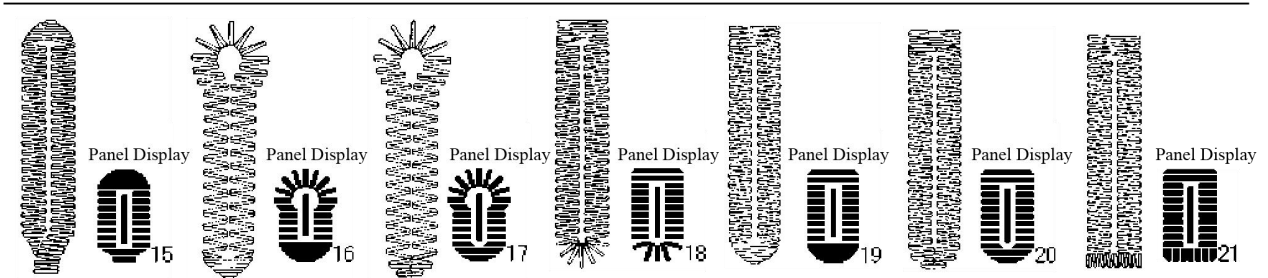

- (22) Square taper bar-tacking type (23) Radial semilunar type (24) Radial round type (25) Semilunar radial type (26) Semilunar round type (27) Bar-tacking (28) Bar-tacking, right cut

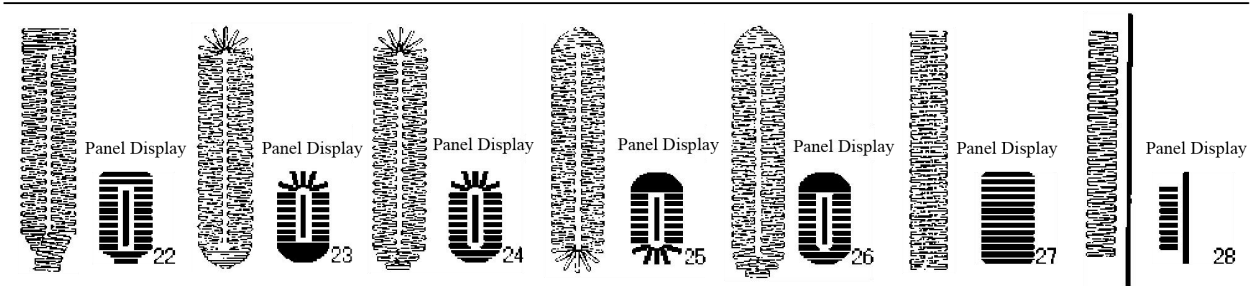

- (29) Bar-tacking, left cut (30) Bar-tacking, central cut (31) Basting + knife

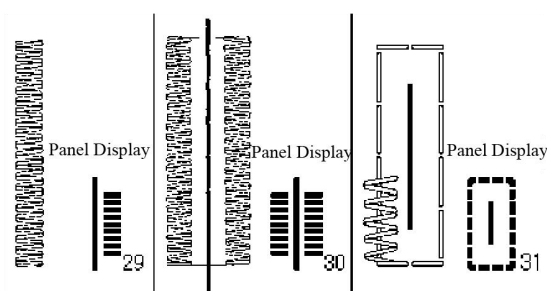

### 3. Structure

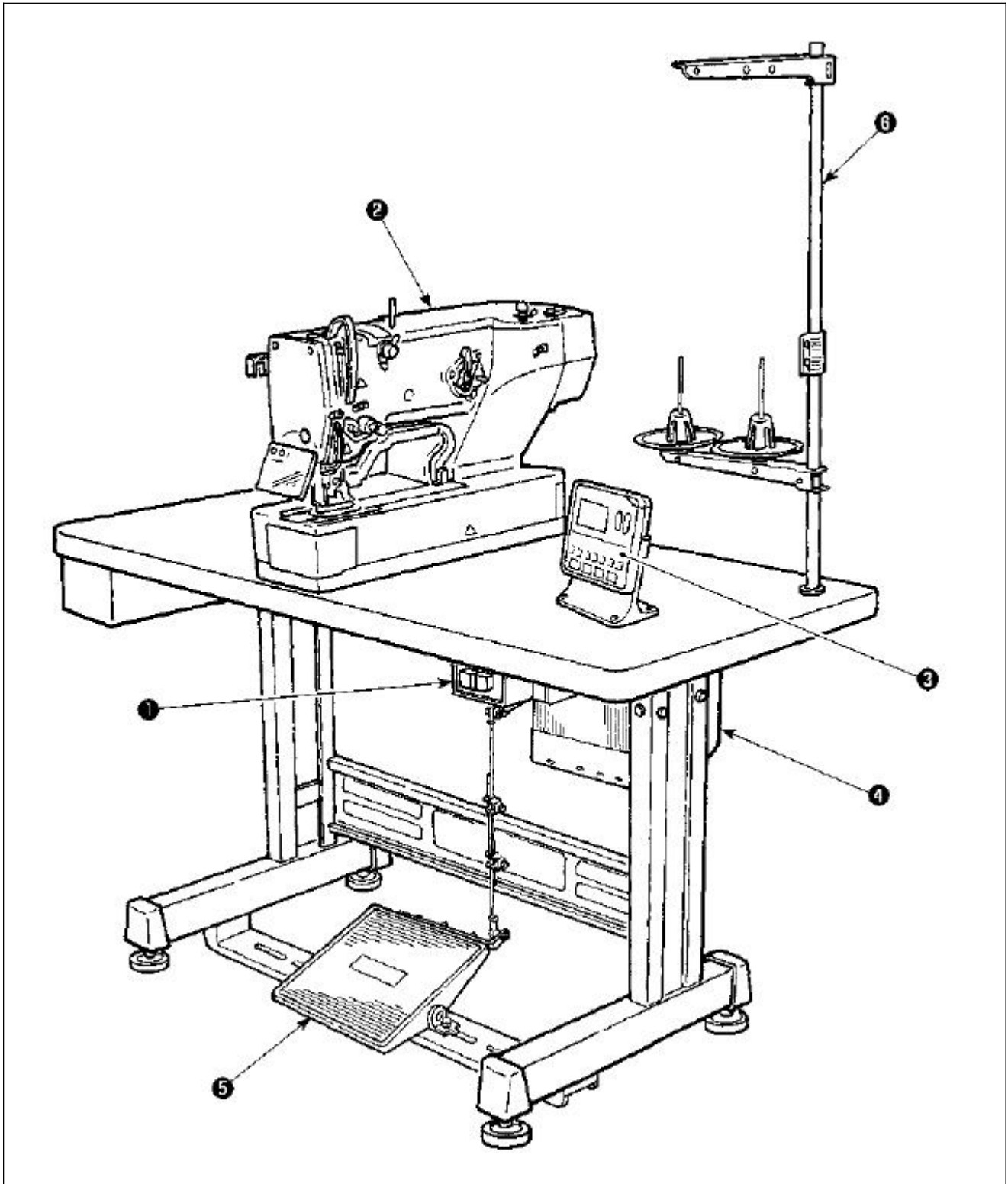

CSM-1790A is composed of the following components

①	Power switch
②	Sewing machine head (CSM-1790A)
③	Operation panel
④	Electrical box
⑤	Pressor lifting pedal
⑥	Thread stand device

### III. Installation

#### (1) Table Assembly

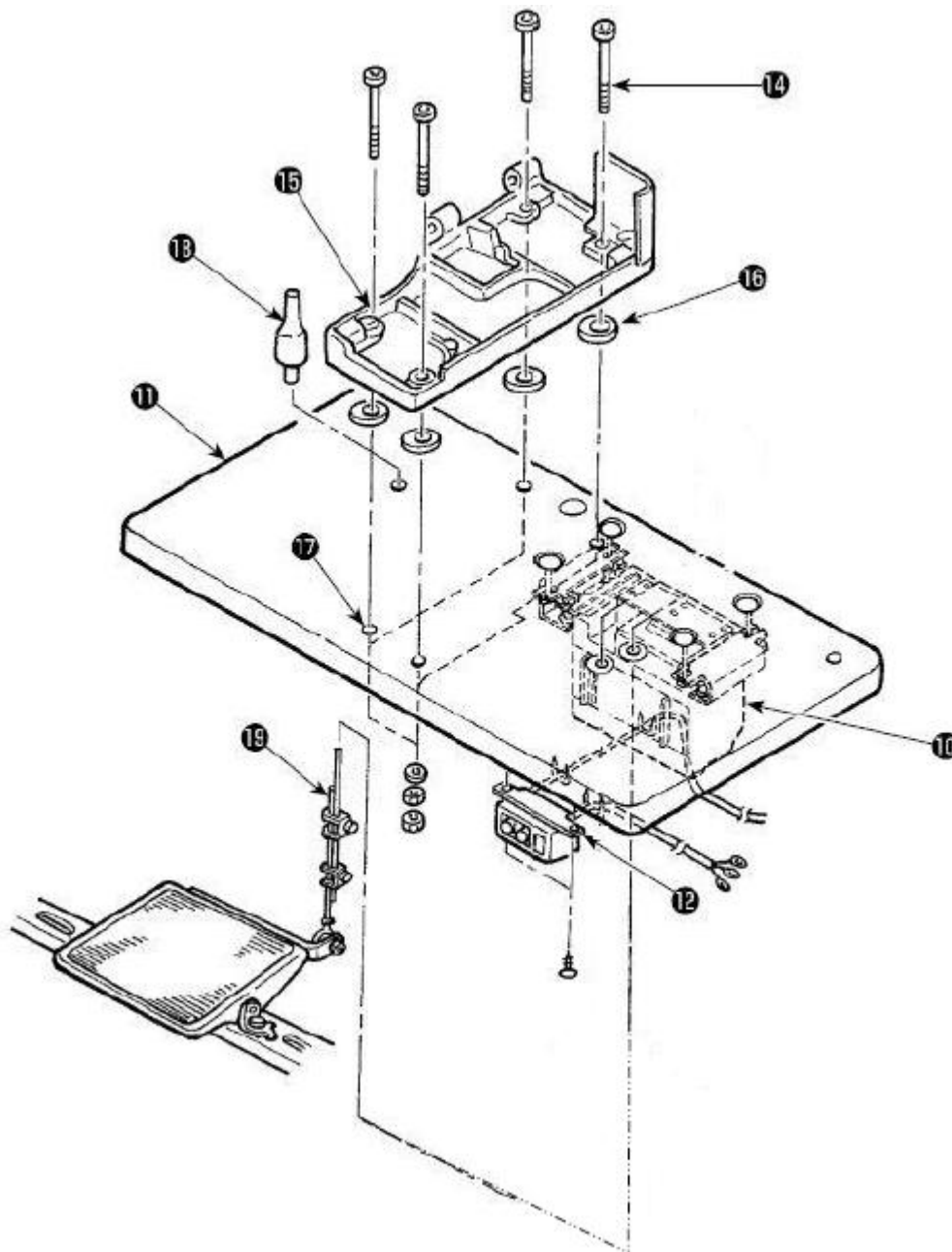

- 1) Fix control box(10) and power switch(12) on the table.
- 2) Fix the power switch(12) with fixing strip.
- 3) Pass four bed base fixed screws (4) through bed base.
- 4) Install rubber cushions (16) to holes(17) (4) for fixing bed base and the fixe the bed base(15).
- 5) Fix machine head support bar(11) on the table(11).
- 6) Connect the pedal and pedal sensor(13) with accessory connecting rod(19) after placing the sewing machine main body on the bed base(15).



(2) Connecting the power cord

**Voltage specification**

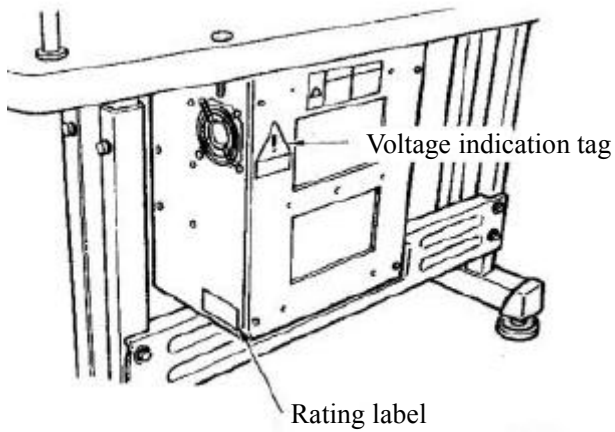

Power source specifications are indicated on the voltage indication tag and the rating label. Please choose cables according to the specification.



Please do not run the machine under different voltage specifications.

Connection for single phase 200V, 220V, 230V and 240V

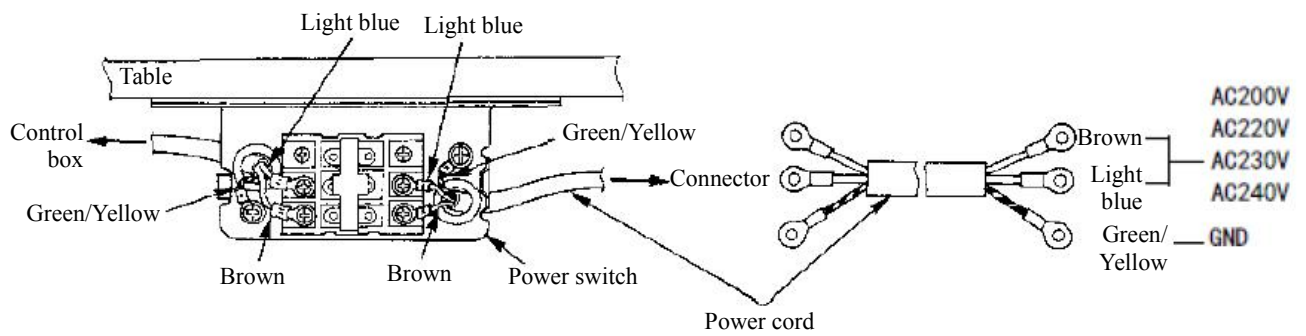

(3) Installation of the sewing machine main unit

**Caution** When handling the sewing machine, be sure to perform the work with two persons or more.

Install hinges **1** and bearing blocks **2** (**2**-1: rubber, **2**-2: metal) on machine head position 2, and fix hinge plates on the sewing machine head with setscrews **3** in two positions.

Please do not install the rubber hinge and metal hinge in reverse sequence. Otherwise, danger may be caused when the sewing machine is tilted.

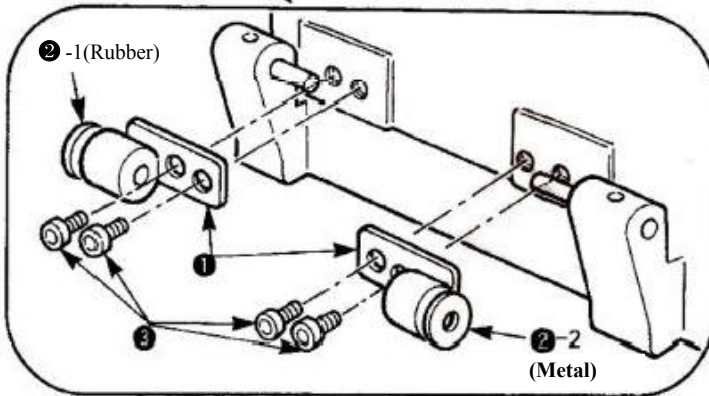
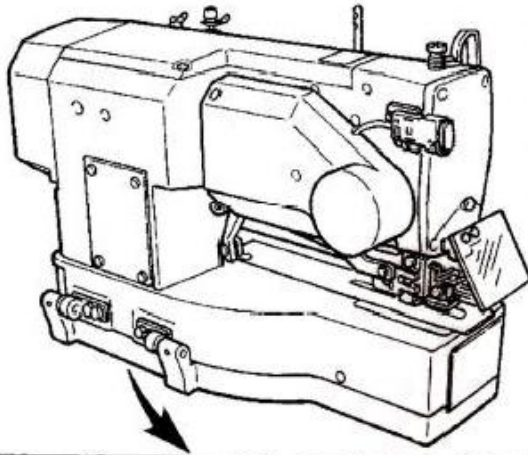

(4) Tilting method of sewing machine

**Danger** Perform the work so as not to allow your fingers to be caught in the machine when tilting or raising it. In addition, to avoid possible accidents caused by abrupt start of the machine, turn OFF the power to the machine before starting the work.

When tilting the sewing machine head, tilt quietly the sewing machine until head support bar **1** comes in contact with it.

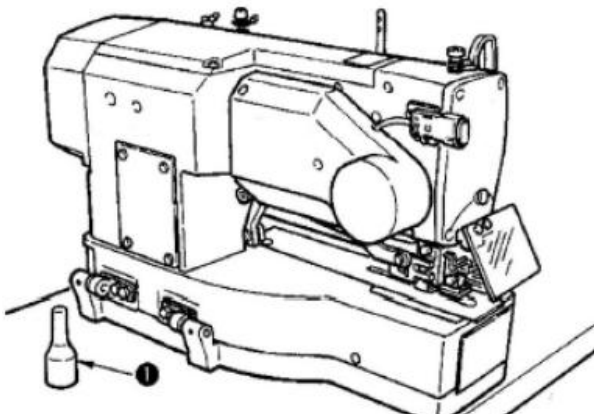

1. Before tilting the sewing machine, please confirm whether a support bar **1** has been installed on the table.
2. In order to prevent sudden fall of the sewing machine, please place it horizontally and then tilt it.

(5) Connection of machine head tilting detector

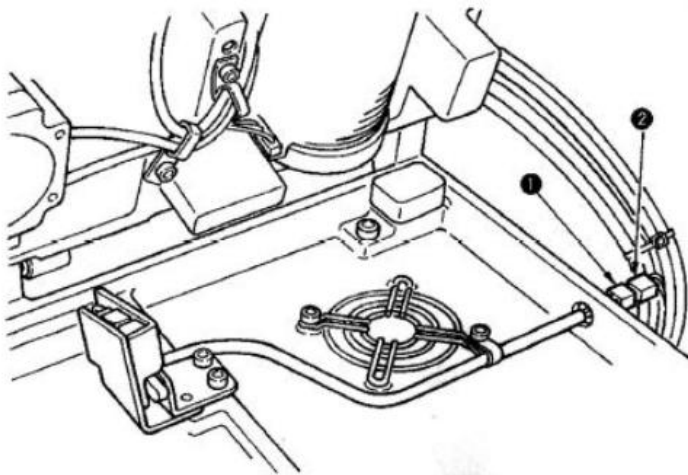

- 1) Connect the safety switch connector**1** to the connector**2** on the machine head side.

(6) Installation of the hook oil-proof plate

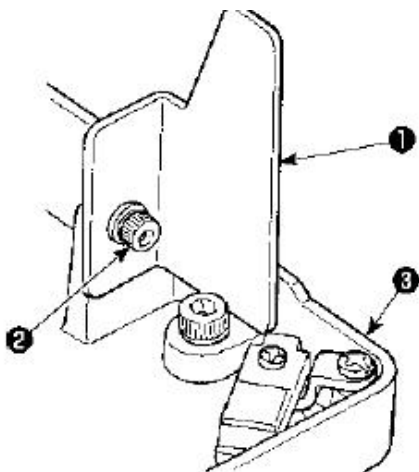

---

(7) Installation of operation panel

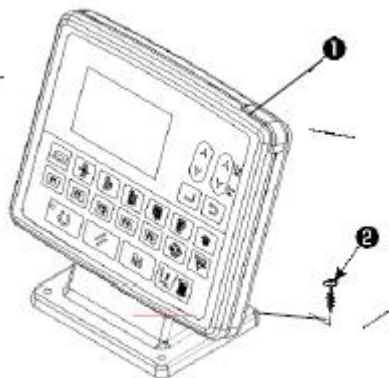

Please fix the operation panel**1** with 4 wood screws**2** and then pass the cable through the table hole.

(8) Connection of the cable

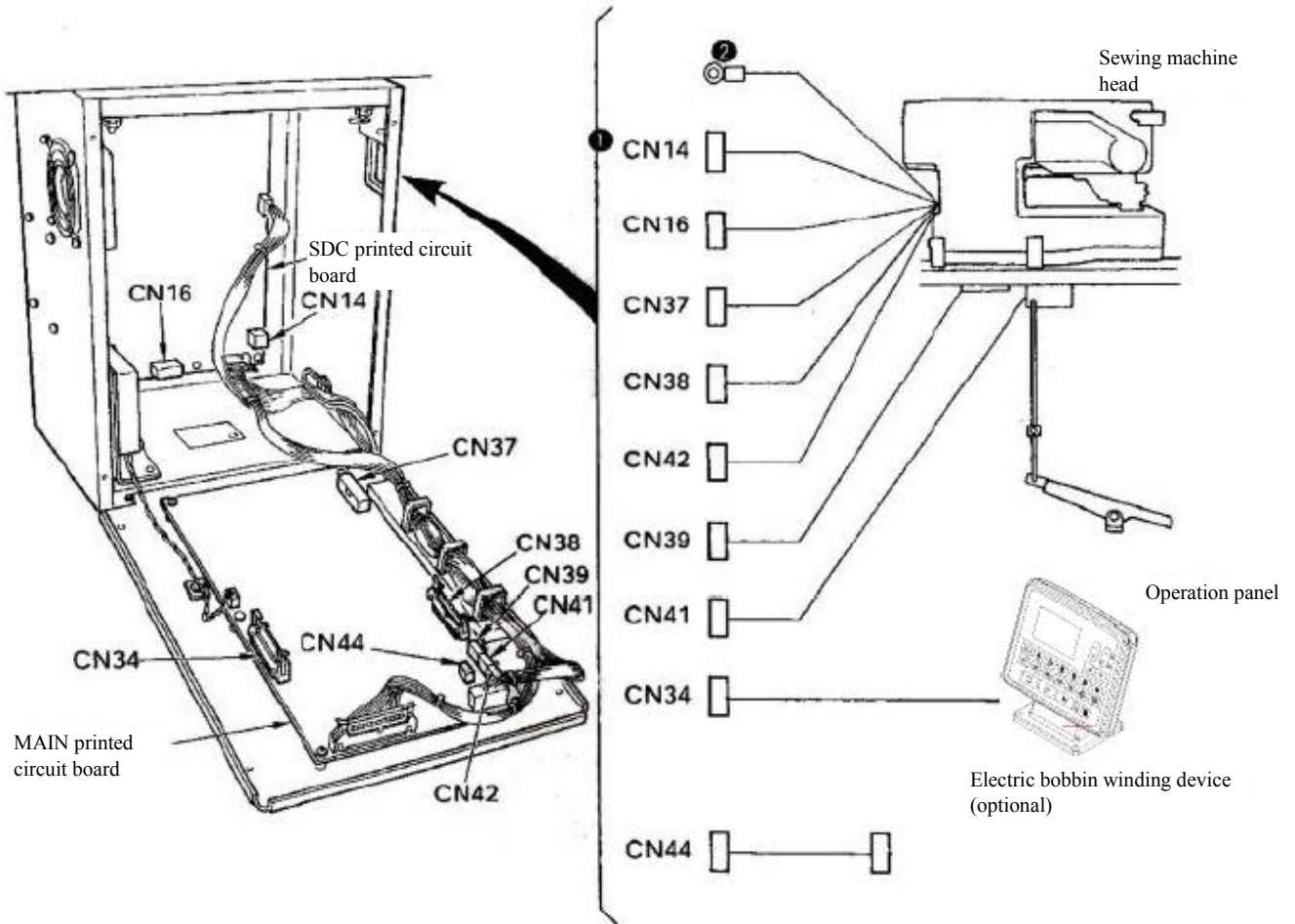

SDC printed circuit board

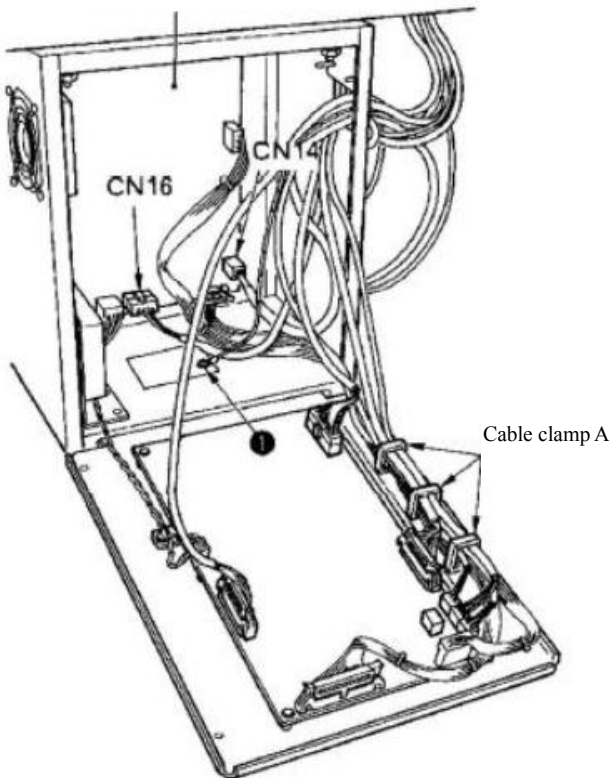

- 1) As shown in the figure, pass 4 cables, which are on the right part of cables connected to the MAIN printed circuit board, through cable clamp A and insert them to corresponding connectors (CN38, 39, 41, 42). Insert the cable connected to CN37 directly to the connector without passing through cable clamp A. In addition, when using electric bobbin winding device (optional), please pass the cable through the cable holder and then connect it to CN44.
- 2) Directly insert the cable connected to the operation panel on the left of MAIN printed circuit board to CN34.
- 3) Directly insert cables connected to SDC printed circuit board to CN14 and CN16.
- 4) Secure the ground wire with the setscrew ❶.

(9) Handling of the cord

- 1) Please tilt the sewing machine slowly while confirm that no cable is forcibly pulled.
- 2) As shown in the figure, secure cables with cable fixing plate①.



When tilting the sewing machine, please make sure that the machine head support bar② has been installed on the table.

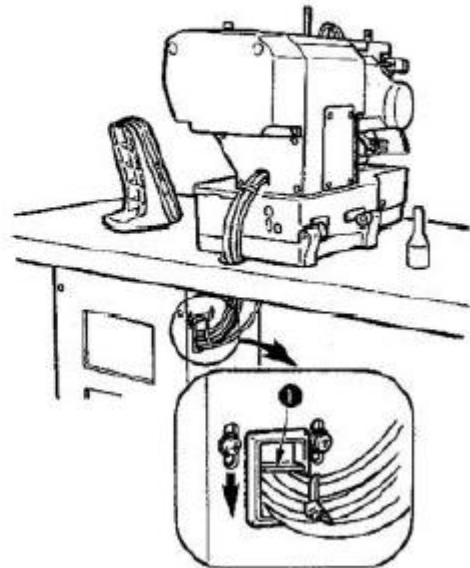
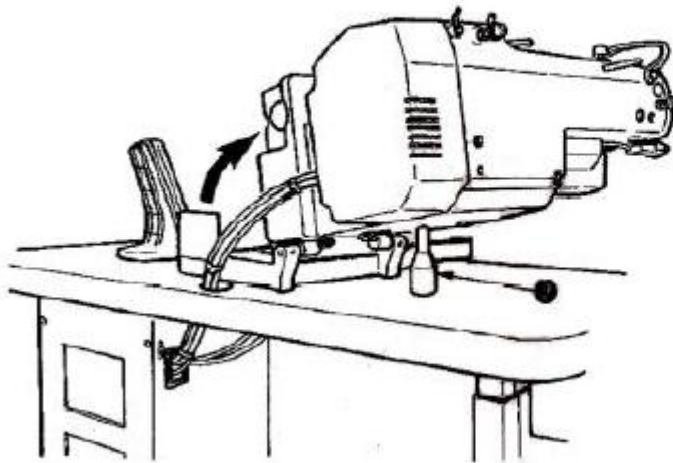



(10) Installation of the eye protective cover



**Warning**

Be sure to attach this cover to protect the eyes from the disperse of needle breakage.

Please make sure the eye protective cover **1** has been installed before operating the sewing machine.

When placed longitudinally

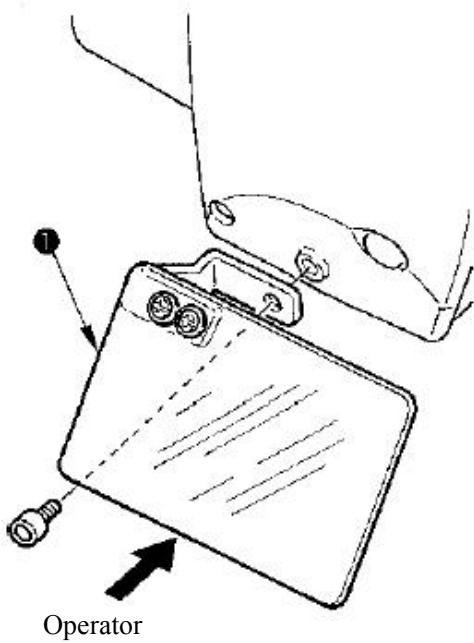

When placed horizontally

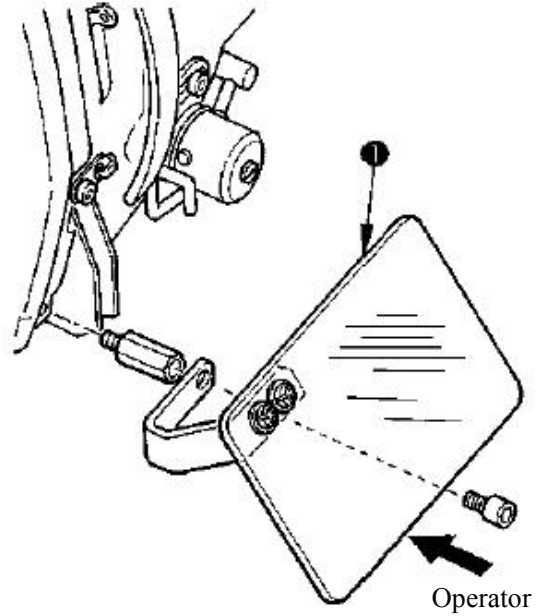

---

(11) Fixation of STOP switch

At the time of delivery, the STOP switch is in state A. Please loosen the setscrew **1** to change it into state B, and

then fix it with accessory setscrew **2** and the setscrew **2**.

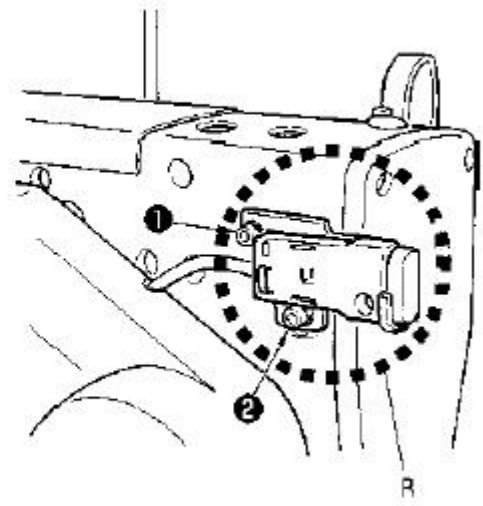
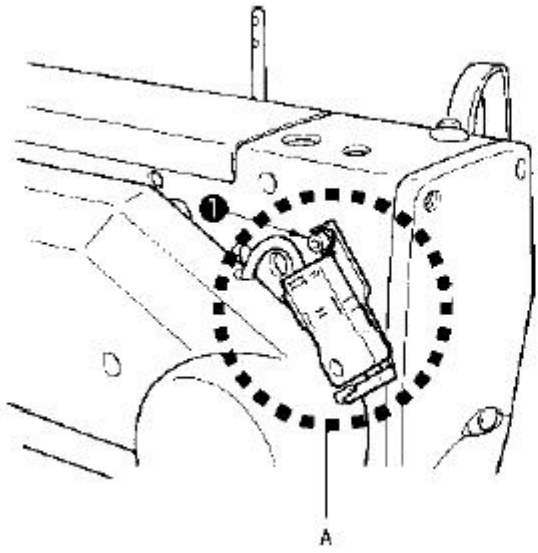

(12) Guide rod

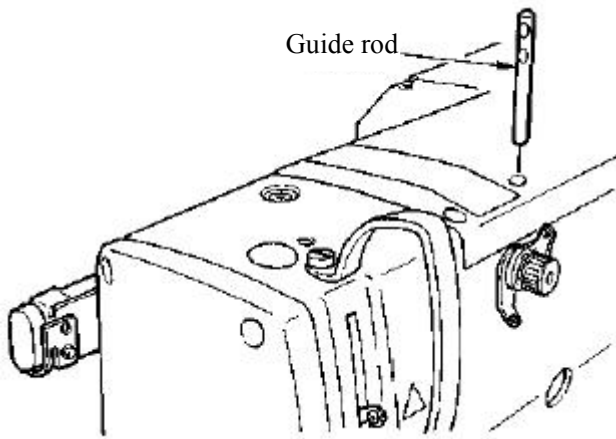

Securely fit the thread guide rod so that two side holes in the thread guide rod face the thread guide.

(13) Installation of thread stand

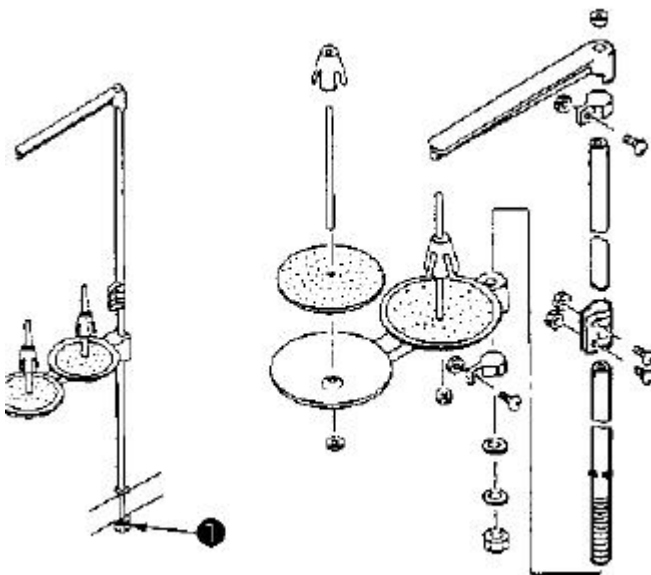

- 1) Assemble the thread stand into the holes on the top right of the table.
- 2) Tighten the setscrew **1** to fix the thread stand.



(14) Installation of auxiliary table

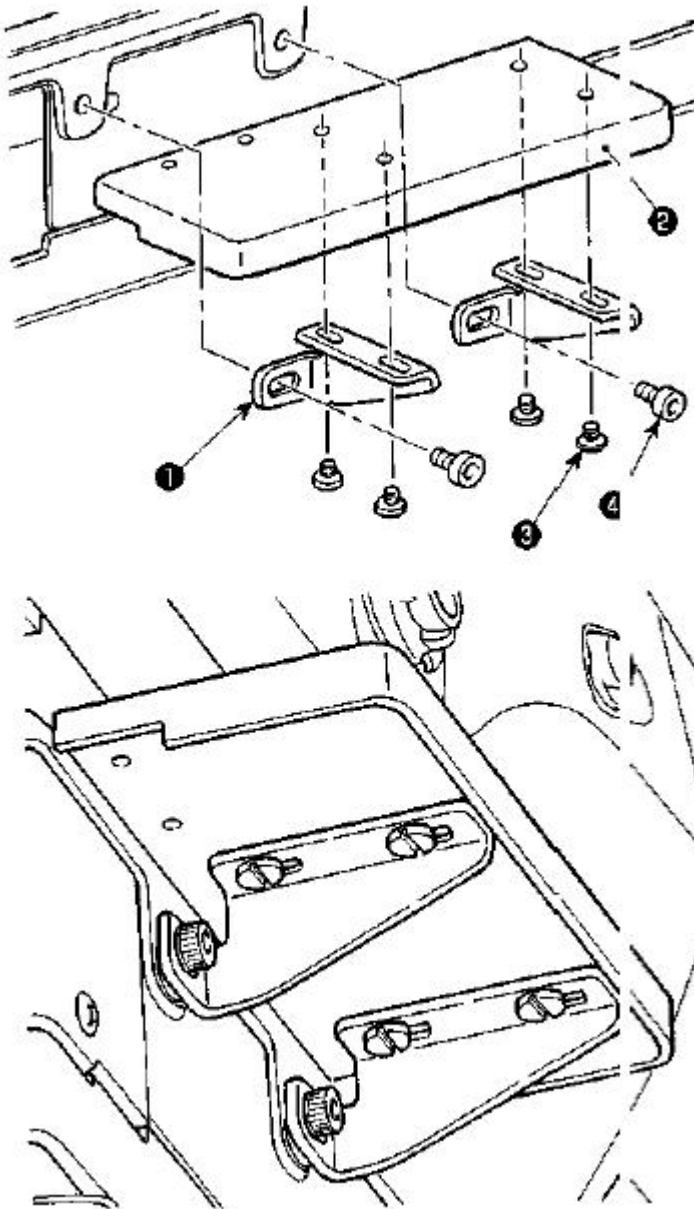

- 1) Fix the auxiliary table mounting plate① (2) with bolts③ (4) on the auxiliary table temporarily.
- 2) Fix the auxiliary table ② with bolts③ (2) on the sewing machine bed temporarily.
- 3) Fix the bolts③ (4) to remove the clearance between the sewing machine bed and the auxiliary table.
- 4) Fix the bolts④ (2) to align the auxiliary table with the upper side of the sewing machine bed.

## IV. Operation Preparation

### 1. Lubrication

**! Warning** Please turn off the power switch and confirm that the motor has stopped before operation to prevent personal injuries caused by unexpected start.

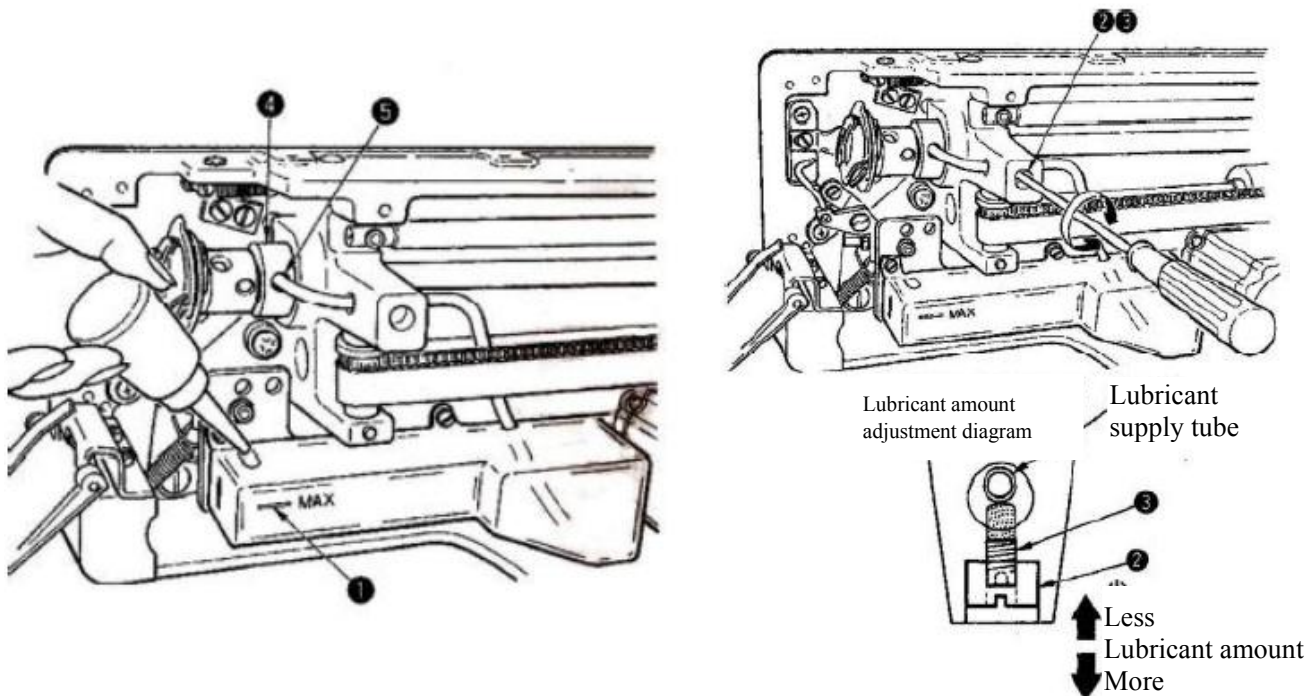

- 1) Lubricating oil to oiling tank
  - ◆ Fill the oiling tank with New Defrix Oil No.1 up to the level indicated by MAX ①.
- 2) Adjust the lubrication for the sewing hook
  - ◆ The amount of oil is adjusted with oil amount adjusting screw②.
  - ◆ Amount of supplied oil is reduced when turning the screw② clockwise.
  - ◆ For newly-installed sewing machine or sewing machine out of service for a long time, please remove the bobbin case and drip 2-3 droplets of oil on the side slots of the cover. In addition, drip several droplets of oil into the oiling hole in the metal parts③ in front of the lower shaft, and make the oil infiltrate into the felt inside the hole.

### 2. Attaching the needle

**! Warning** Please turn off the power switch and confirm that the motor has stopped before operation to prevent personal injuries caused by unexpected start.

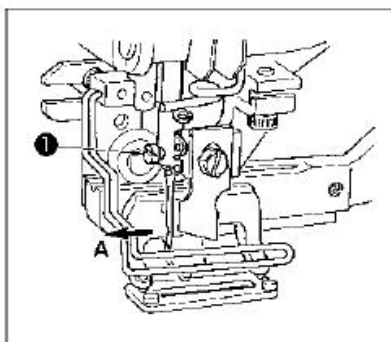

Hold needle with its recessed part facing toward the operator side A.  
Then deeply insert the needle into the needle bar hole and tighten the needle setscrew①.  
Use a DPX5-(#11J, #141) needle.



Turn off the power switch before attaching the needle.

### 3. Threading the needle thread

**! Warning** Please turn off the power switch and confirm that the motor has stopped before operation to prevent personal injuries caused by unexpected start.

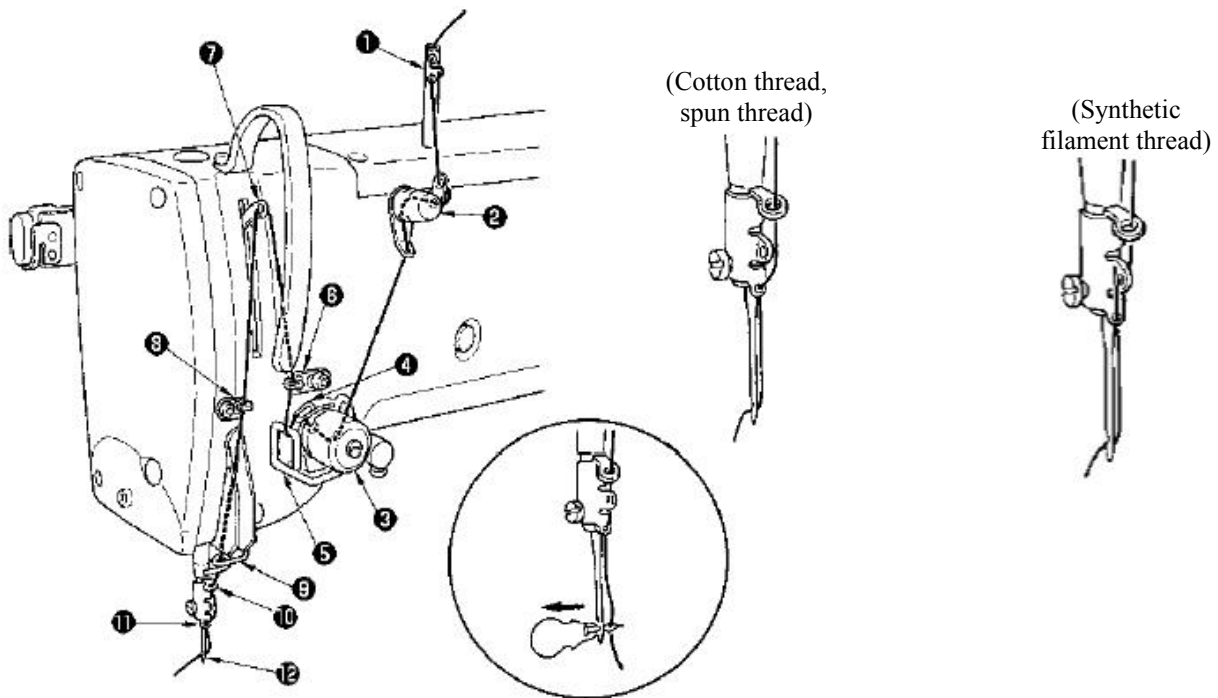

Thread as per the order as shown above.  
The threading can be done easily by using the needle threader supplied with the machine.  
For different thread, different methods shall be used for the thread guide.

### 4. Threading the bobbin case

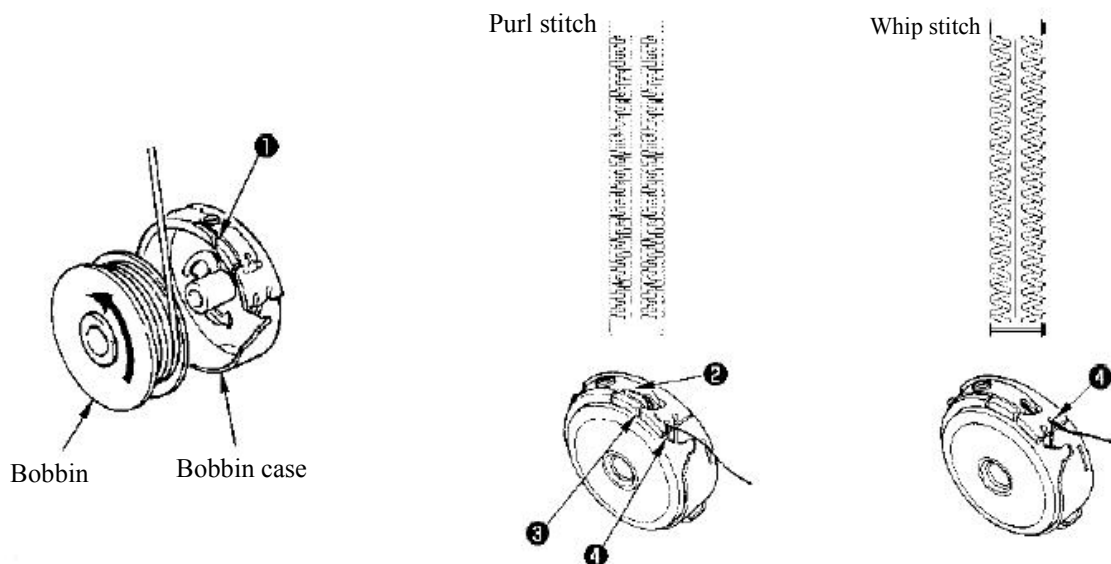

Rotating direction of bobbin and threading

- 1) Insert the bobbin in the direction of arrow.
- 2) Pass the thread through thread slit①, then pass through the tension spring② from the bottom, and repass through the thread slit③ to pull the thread out from④.
- 3) Please note that when conducting purl stitching and whip stitching sewing, threading methods for④ will be different.

## 5. Adjusting bobbin thread tension

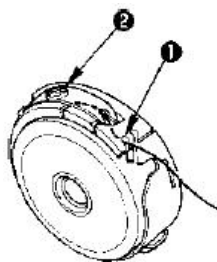

Adjust the bobbin thread tension as given below when the bobbin thread is pulled up at the position where thread slit **1** of bobbin case comes up.

Purl stitch	0.05 ~0.15N	Hold the thread end coming from the bobbin case with hand, shake it up and down <u>lightly</u> and the bobbin case will drop <u>slightly</u> .
Whip stitch	0.15 ~0.3N	Hold the thread end coming from the bobbin case with hand, shake it up and down a little more strongly and the bobbin case will drop.

When turning the thread tension screw **2** clockwise, the bobbin thread tension will be increased, and turning it counterclockwise, the bobbin thread tension will be decreased.

For synthetic thread, reduce the tension slightly. For cotton thread, please increase the tension slightly. Increase the thread tension by around 0.05N after the hook has been installed because an anti-spin spring has been installed in the machine.



Caution When bobbin thread tension is adjusted, check the needle thread tension setting of the memory switch. (Refer to “V-22. List of memory switch data” p.52)

## 6. Installing bobbin case

**! Warning** Please turn off the power switch and confirm that the motor has stopped before operation to prevent personal injuries caused by unexpected start.

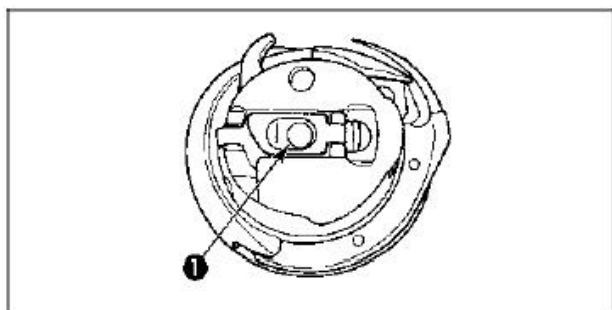

- 1) Raise the bobbin case latch lever.
- 2) Push the bobbin case into the hook so that it is supported by the hook shaft **1** and then snap the

latch lever. Press the bobbin case until the predetermined position is reached, it will click.

1. If the bobbin case is not in the required position, it can jump out from the hook to cause the needle thread to tangle on the hook shaft. Check to be sure that the bobbin case is properly installed in the correct position.



2. Because shapes of standard hook and dry-type hook are different, any type of hook cannot be replaced by the other.



## 7. Installing the knife

**! Warning** Please turn off the power switch and confirm that the motor has stopped before operation to prevent personal injuries caused by unexpected start.

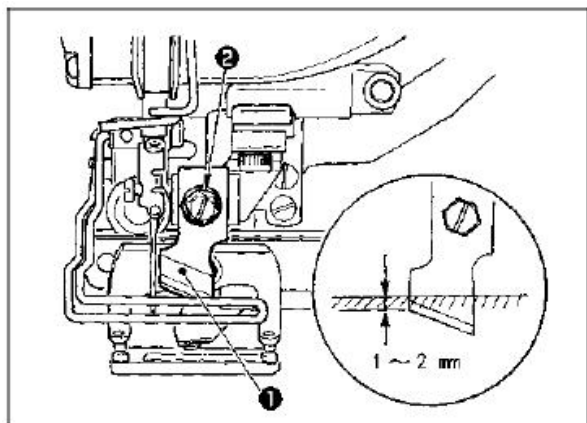

Please change new knife according to the following steps.

- 1) After removing the knife setscrew, the knife ❶ and washer can be removed easily.
- 2) After pressing the knife bar down, install the knife to 1 ~ 2mm above the throat plate as shown in the figure. Please make sure to install and tighten the washer.

Inch -4 mm conversion table

Knife size	In mm
1/4	6.40
3/8	9.50
7/16	11.10
1/2	12.70
9/16	14.30
5/8	15.90
11/16	17.50
3/4	19.10
13/16	20.60
7/8	22.20
1	25.40
11/8	28.60
11/4	31.80
13/8	34.90
1 1/2	38.10

If the knife in service is displayed as inch, please check “Inch - mm conversion table” to set length of the knife in mm (knife size). (Refer to “V-13 List of sewing data” p.33)

## 8. Checking the delivery state

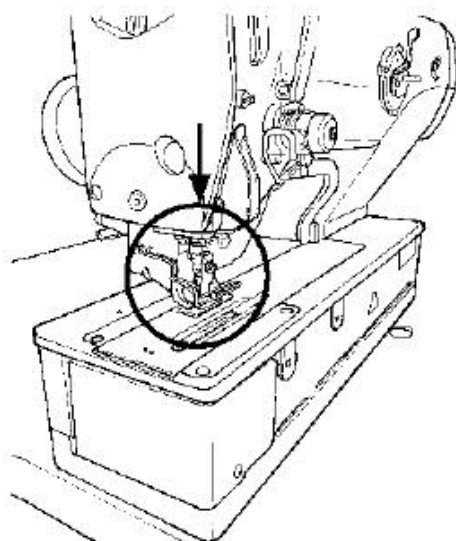









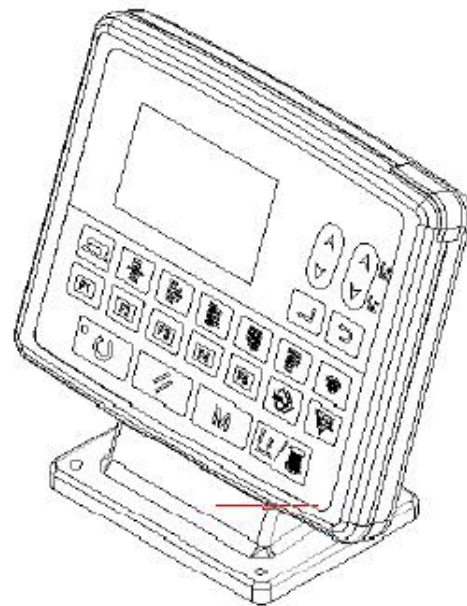
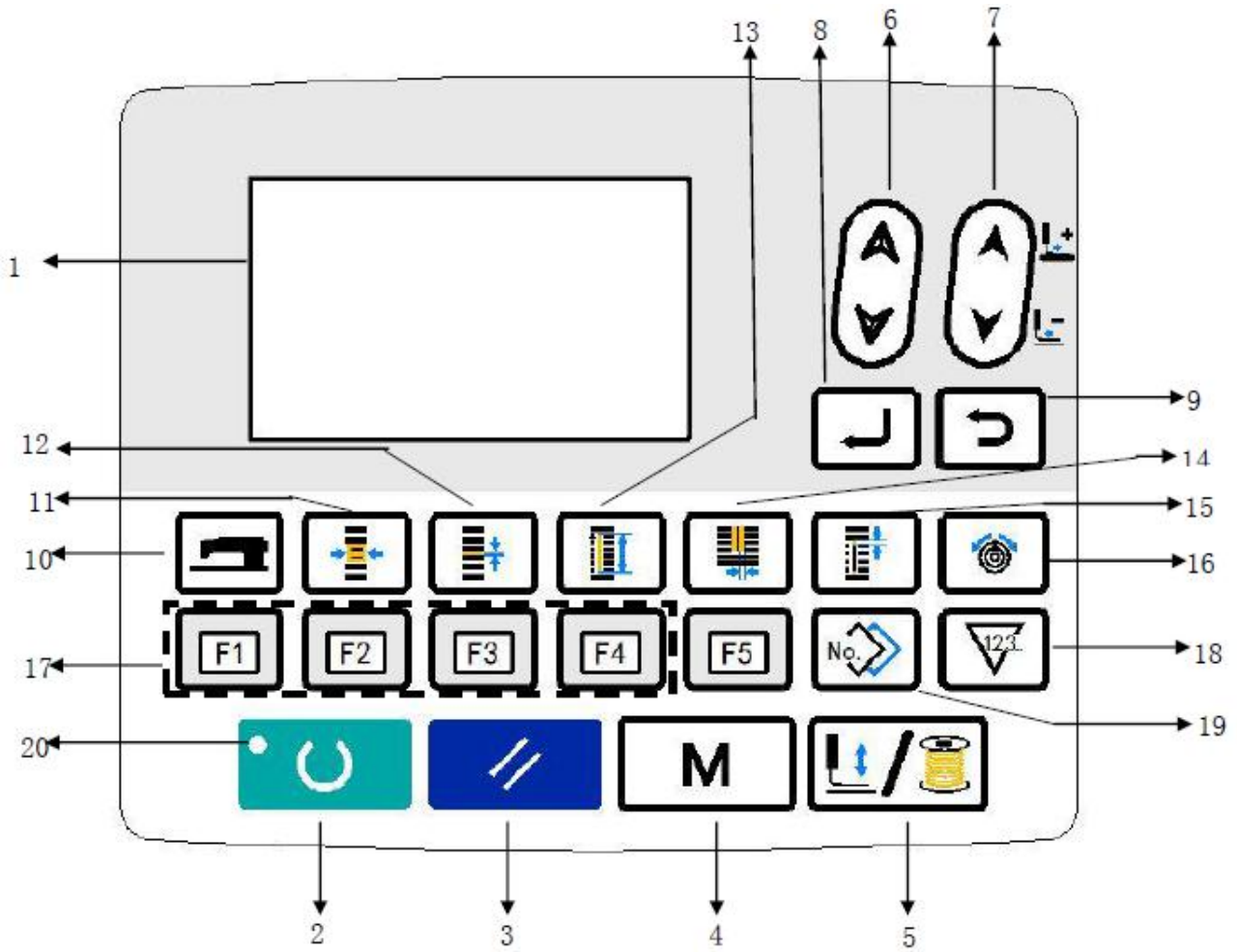









If the presser foot of the delivered machine is lifted, please drop down the presser foot before switching on sewing machine's power. Caution When dropping down the presser foot, take care not to put your hands near the knife.

When the presser foot is lifted and the power is switched on, if the Ready key is pressed, “E998 presser foot deviation” may occur.

## V. Operation of the Sewing Machine

### 1. Description operation panel switch



No.	Name	Function	No.	Name	Function
①	LCD display	Display data such as pattern No., shapes, etc.	⑪	Overedging Width key 	This key selects overedging width display. Every time this key is pressed, S005 and S006 will be displayed alternately.
②	Ready key 	Press this key when sewing starts. After pressing the key, change-over of sewing ready set state and data set state can be performed.	⑫	Pitch key 	This key selects pitch of parallel section. Every time this key is pressed, S007 and S021 will be displayed alternately.
③	Reset key 	Press the key to reset errors, move to original position, reset counting, etc.	⑬	Cloth cutting length key 	This key selects Cloth cutting length.
④	Mode key 	This key is used to displaying mode screen.	⑭	Knife Groove Width key 	This key is used to select the knife groove width correction display. Every time this key is pressed, S003 (right) and S004 (left) will be displayed alternately.
⑤	Presser & Winder key 	This key lifts or lowers the presser. When the presser goes up, the needle bar travels to the origin and when it comes down, the needle bar travels to the right. Press the key when bobbin winding.	⑮	Clearance key 	This key selects clearance display. Every time this key is pressed, S022 (1 <sup>st</sup> clearance) and S023 (2 <sup>nd</sup> clearance) will be displayed alternately.
⑥	Item selection key 	This key selects the data No. and other data.	⑯	Thread Tension key 	This key is used to select the thread tension display. Every time this key is pressed, the display item is changed over as described below: S052 Tension of right parallel section S053 Tension of left parallel section (1 <sup>st</sup> circle of double sewing) S054 Tension of right parallel section (1 <sup>st</sup> circle of double sewing) S055 1 <sup>st</sup> Bar-tacking section tension S056 2 <sup>nd</sup> Bar-tacking section tension
⑦	Data Change key 	This key is used to change pattern No. and other data. This key is also used to move the feed forward on a stitch-by-stitch basis.	⑰	Parameter Registration key 	This is a short cut key that parameter registration is available. Registration of shortcut to setting display of an optional pattern, sewing parameter or adjustment data is possible. Refer to “V-16. Using parameter registration key” P. 42 for setting methods.
⑧	Edit key 	Display editing screen, select items or display detailed screen.	⑱	Counter key 	This key selects counter display.
⑨	Return key 	Back to the previous screen.	⑲	Copy key 	Press the key when copying patterns.
⑩	Sewing Speed key 	Display editable parameters concerning sewing speed. In addition, sewing speed can be adjusted at any time on sewing screen.	⑳	Set Ready LED	It lights up in sewing mode.





## 2. Basic operation of the sewing machine

### 1) Turn on the power switch

When the sewing machine power is switched on for the first time after you purchase the machine, language selection screen A will be displayed. After the language has been selected,

please press Return key .

 In case that Return key  is pressed without selecting any language, the language selection screen will be displayed every time the power is switched on.

~~First, please confirm whether the type of the set presser (type B) is consistent with the installed presser. Refer to “V-4. Input of the presser type” P.23 for confirmation and setting methods.~~

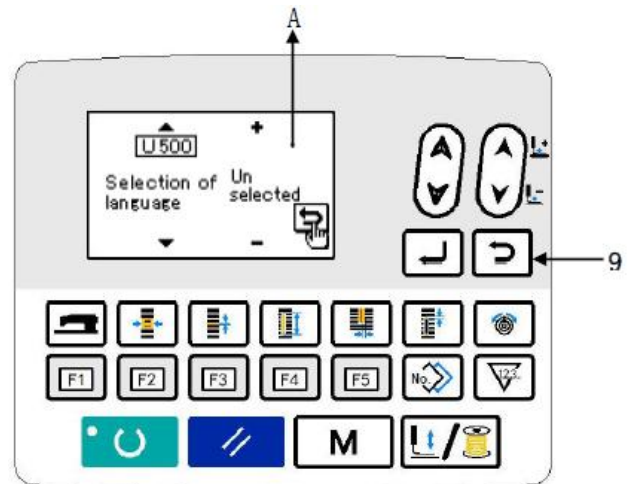



### 2) Select the pattern No. you desire to sew

The selected pattern No. C is displayed when the power is switched on.

In case of pattern change, press the Data Change

key  and select the intended pattern No. Pattern No. 1-10 as specified “V-11. Change sewing data” p.31 in have been registered when you purchase the machine. Therefore, such selection is operable. (In case of unregistered pattern, the pattern No. will not be displayed.)

### 3) Ready-to-sew state

Press the Ready key , then the Set Ready LED  will light up, indicating that the sewing is enabled.

### 4) Star sewing

Put the cloth under the presser, depress the presser, and the sewing machine will start. When you purchase the sewing machine, single pedal specification will be set up, and 4 types of pedal operation methods can be selected. Please select your favorite operation method.

→“V-3. Pedal operation method” p.21

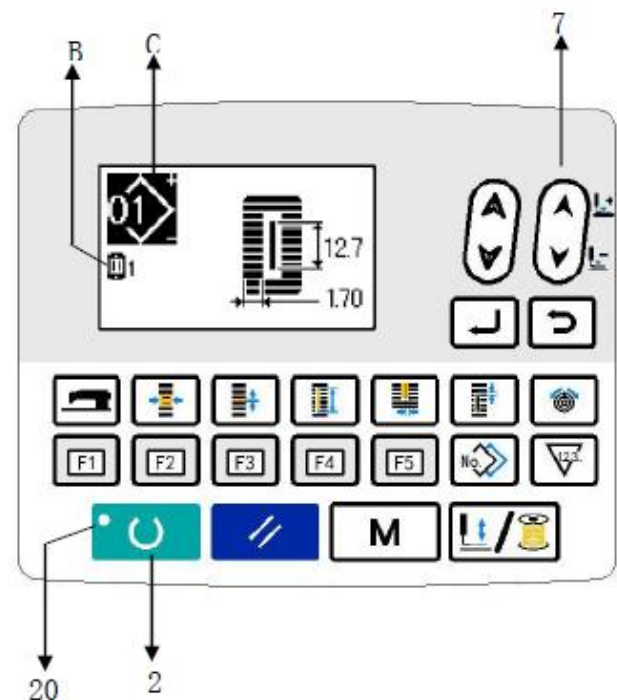



### 3. Pedal operation method

The following 4 types of pedal operation methods for this sewing machine can be selected. Please select your favorite highly-efficient operation method.

#### (1) Setting method for pedal type

##### 1) Invoke setting parameters of pedal type

Under input mode with Set Ready LED <sup>20</sup> switch off, press Mode key <sup>4</sup> **M** for over 3 seconds, then the memory switch (Level 2) on the menu will be displayed.

Select with Item selection key <sup>6</sup> . Press the Edit key <sup>8</sup> , and memory switch (Level 2) editing screen A will be displayed.

**K001** If pedal type selection parameters are not displayed, please press Item Selection key

<sup>6</sup> .

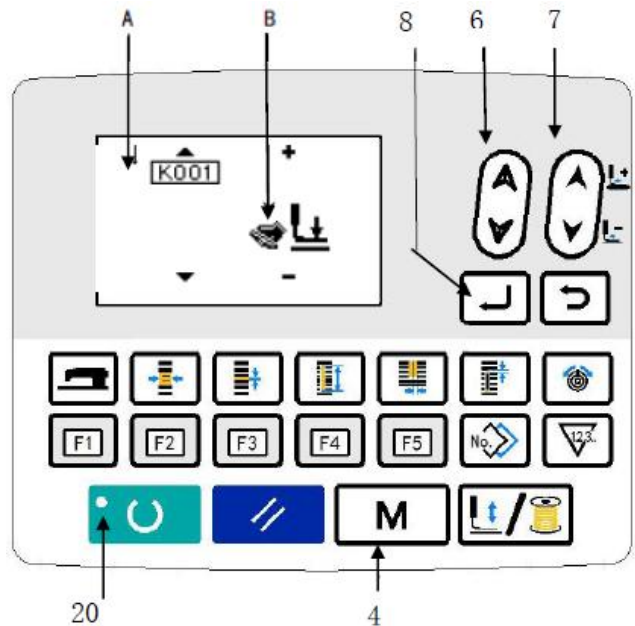

##### 2) Select pedal type

If Data Change key <sup>7</sup>  is pressed, patterns as shown in the figure below will be changed. Therefore, please select your favorite pedal type B.

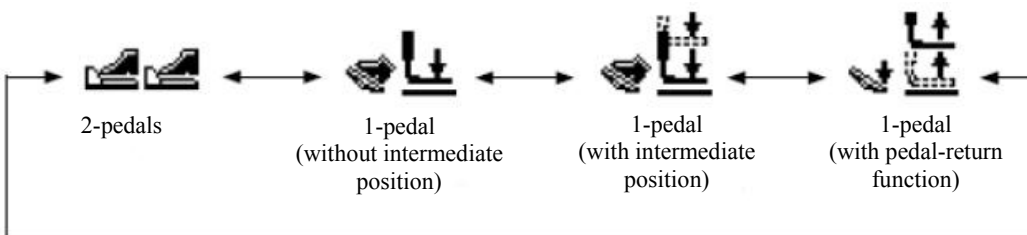

## (2) Pedal action descriptions

<b>2-pedal type</b>	<b>1-pedal (without intermediate position)</b>	<b>1-pedal (with intermediate position)</b>	<b>1-pedal (with pedal-return function)</b>
<p><b>Initial position</b> Presser: <u>Intermediate position ②</u> or <u>Sewing position ③</u></p> <p><b>1) Setting of sewing product</b> Presser goes up as high as the pedal toe down amount of the left side pedal.</p> <p><b>2) Start of sewing</b> Sewing starts when the right side pedal is depressed.</p> <p><b>3) End of sewing</b> Presser automatically goes up to <u>intermediate position ②</u>.</p>	<p><b>Initial position</b> Presser: <u>Maximum position ①</u>.</p> <p><b>1) Setting of sewing product</b></p> <p><b>2) Confirmation of set sewing product</b> Depress the pedal to Level 1, and the presser will drop down to the <u>cloth setting position ③</u>.</p> <p><b>3) Start of sewing</b> Depress the pedal to Level 2, and sewing will start.</p> <p><b>4) End of sewing</b> Presser automatically goes up to <u>maximum position ①</u>.</p>	<p><b>Initial position</b> Presser: <u>Maximum position ①</u>.</p> <p><b>1) Setting of sewing product</b></p> <p><b>2) Confirmation of set sewing product</b> Depress the pedal to Level 1, and the presser will drop down to the <u>intermediate position ②</u>.</p> <p><b>3) Confirmation of sewing start</b> Depress the pedal to Level 2, and the presser will drop down to the <u>cloth setting position ③</u>.</p> <p><b>4) Start of sewing</b> Depress the pedal to Level 3, and sewing will start.</p> <p><b>5) End of sewing</b> Presser automatically goes up to <u>maximum position ①</u>.</p>	<p><b>Initial position</b> Presser <u>intermediate position ②</u>.</p> <p><b>1) Setting of sewing product</b></p> <p><b>2) Confirmation of set sewing product</b> When the pedal is returned, the presser will go up to the <u>maximum position ①</u>. Depress the pedal to Level 1, and the presser will drop down to the <u>intermediate position ②</u>. Depress the pedal to Level 2, and the presser will drop down to the <u>cloth setting position ③</u>.</p> <p><b>3) Start of sewing</b> Depress the pedal to Level 3, and sewing will start.</p> <p><b>4) End of sewing</b> Presser automatically goes up to <u>intermediate position ②</u>.</p>

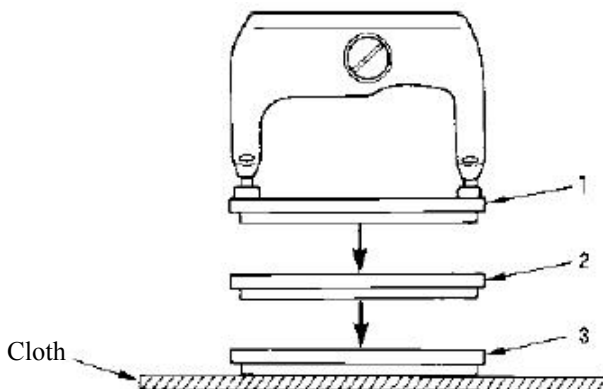

※ Height of the respective positions of ① to ③ described on the left side can be set or changed by the memory switches.

- “V-21. Changing method of memory switch data”

#### 4. Inputting the presser type

##### (1) Setting procedure of the presser type

###### 1) Call the presser type setting parameter

Press “Mode” key **4**  and memory switch

(level 1) edit screen A is displayed.

###### 2) Select the presser type



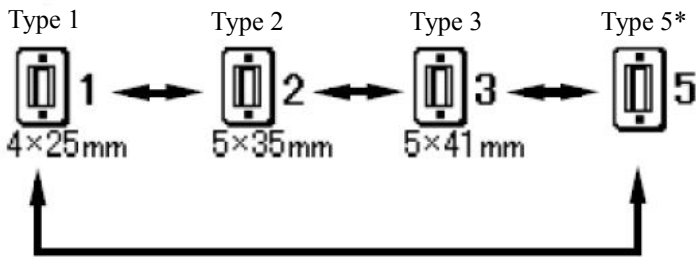
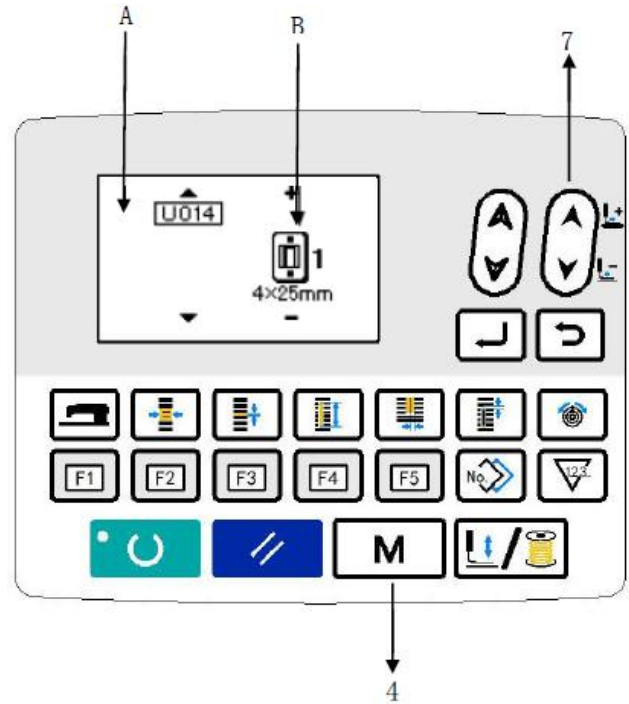

Press Data Change key **7** , and the picture

is changed as shown in the illustration below. See the presser type B mounted on the sewing machine referring to **(2) Table of presser type** below.



##### (2) Table of presser type

Engraved part number of presser should be in line with the type of presser.

	Type	Part No. of presser foot
 4×25mm	Type 1	CS0151177 <b>1</b> 000X
 5×35mm	Type 2	CS0151177 <b>2</b> 000X
 5×41mm	Type 3	CS0151177 <b>3</b> 000X
	Type 5*	-

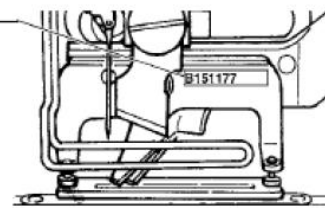

\* Set type 5 when using the presser other than type 1 to 3.

Change **U015** Presser size width and **U016** Presser size length of the memory switch (level 1) to adjust the presser to be used. → Refer to “V-21. Method of changing memory switch data” (P.51).

\* When using type 5 with stitch width of 6mm or more and 41mm or more in length, it is necessary to replace components such as presser arm, feed plate, etc.

## 5. Selecting pattern

### (1) Select from the pattern selection screen

#### 1) Set the mode to the input mode

Under the input mode where Set Ready LED  goes out, pattern selection is enabled.

In sewing mode, press Ready key  to

change over the mode to input mode.

#### 2) Call the pattern selection screen

The currently selected pattern No. A is displayed.

#### 3) Call the pattern selection screen

Press Data Change key  , and the patterns

which have been registered are changed over in order and displayed. Now, select pattern No. you desire to sew.

### (2) Select by means of the register key

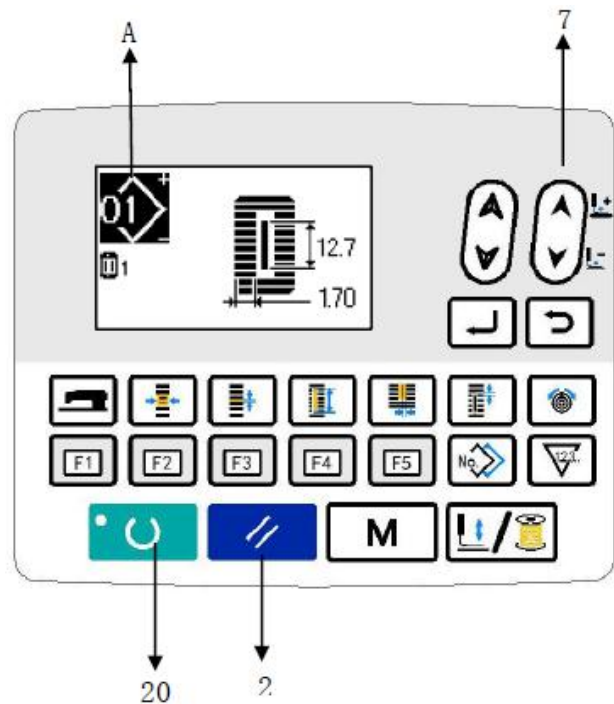

This sewing machine can register the pattern No. you like in Parameter Register key. When the pattern is registered once, pattern selection can be performed by pressing only the switch. → Refer to “V-16. Using parameter register key” (P.42).



## 6. Change needle thread tension

Needle thread tension can be changed while performing trial sewing since the data related to the needle thread tension can be set by the sewing mode as well.

### 1) Call thread tension setting data at parallel section

Press “Thread Tension” key   and the sewing data edit screen A is displayed.



### 2) Change thread tension at parallel section

Press Data Change key   to increase or

decrease set value B, then the thread tension can be changed.

The relation between the sewing effect and the set value is as shown in the illustration below. Set the value referring to the illustration.

### 3) Call thread tension setting data at bar-tacking section

Press “Thread Tension” key   again and the sewing data edit screen C is displayed.

### 4) Change the needle thread at bar-tacking section

Press Data Change key   to increase or



decrease set value D, then the thread tension can be changed.

The relation between the sewing effect and the set value is as shown in the illustration below. Set the value referring to the illustration.

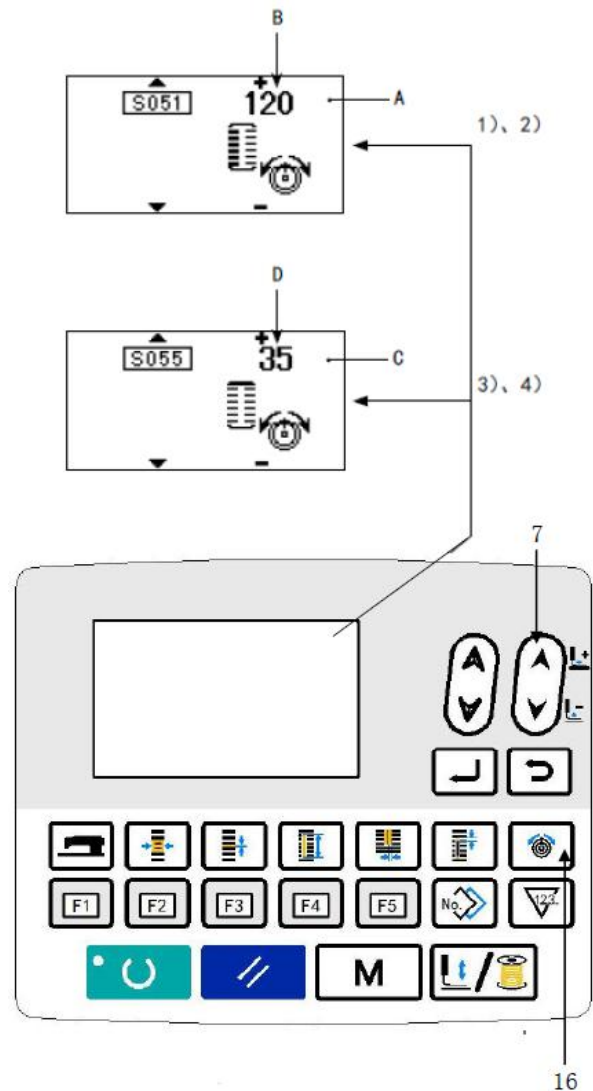
※ For the tension other than that at parallel section and bar-tacking section, refer to “V-11. Changing sewing data” p.31 and “V-21. Method of changing memory switch data” p. 51.



### Set value of tension at 1 parallel section and 2 bar-tacking section

		Set value on panel		
			Initial value	
Purl stitch	① Tension at parallel section	Crest is lowered	1.20	Crest is raised
	② Bar-tacking tension	Thread tension is decreased	35	Thread tension is increased
Whip stitch	③ Tension at parallel section	Thread tension is decreased	60	Thread tension is increased
	④ Bar-tacking tension	Thread tension is decreased	60	Thread tension is increased

For the eyelet radial shape, set the bar-tacking tension first to approximately 120 and make the balance of stitches.

### Whip stitch and purl stitch

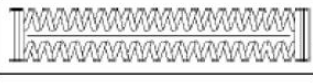
 <p><b>Purl stitch</b></p> <p><b>Whip stitch</b></p>	<p><b>Purl stitch</b> When applying higher tension to the needle thread to permit it to pass straight through fabric, the purl stitch is formed by the bobbin thread which is pulled over from both sides to the center line.</p>
 <p><b>Whip stitch</b></p>	<p><b>Whip stitch</b> The whip stitch is formed in zigzag showing the needle thread only on top of fabric, and the bobbin thread on the back.</p>

## 7. Performing re-sewing

When stop switch A is pressed during sewing operation, the sewing machine will stop. At this moment, error display screen B is displayed to inform that the stop switch is pressed.

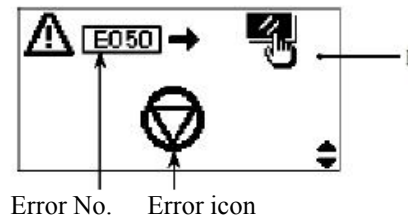
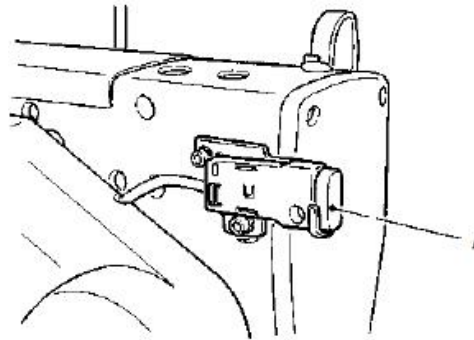

To continue performing sewing from some point in sewing

Sewing motion stop status

Error display screen B is displayed

1) Release the error

Press Reset key to release the

error. Then the step motion screen C is displayed.

2) Return the presser

Press Backward key and the

presser returns stitch by stitch. Press Forward

key and the presser advances

stitch by stitch. Return the presser to the re-sewing position.

3) Restart the sewing

Depress the right pedal to restart the sewing.

Perform again the sewing work from the start.

Sewing motion stop status

Error display screen B is displayed

1) Release the error

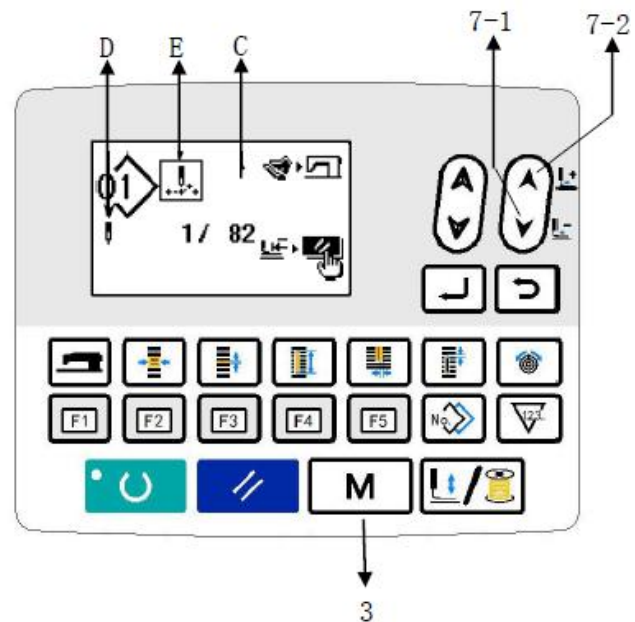

※Existing number of stitches/total number of stitches are displayed in section D.

※Existing sewing command is displayed in section E.

Sewing command



Jump feed command



Thread trimming command



Knife command





Press Reset key  to release the error.

Then the step motion screen C is displayed.

- 2) Return the pressor to the sewing object setting position

Press again Reset key  and the

presser returns to the sewing object setting position (starting position).

- 3) Perform again the sewing work from the start.

## 8. Winding bobbin thread

### (1) Winding the bobbin

#### 1) Set the bobbin

Fit a bobbin fully onto the bobbin winder shaft. Take the thread from the spool and pass it through the guides in the numerical order as shown in the figure, and wind the end of the thread several times around the bobbin. Then push the bobbin winding lever ① in the direction of the arrow mark.

#### 2) Set the mode to the bobbin winding mode

Under the input state, press Presser and Winder

key . In this state, press Item Select

key .

#### 3) Start bobbin winding

Depress the pedal, and the sewing machine rotates and starts winding bobbin thread.

#### 4) Stop the sewing machine

Once the bobbin is wound with the predetermined amount of thread, bobbin winding lever ① will be released. Press Presser and Winder key

 or depress the pedal to stop the

sewing machine. Then remove the bobbin and cut bobbin thread with thread trimmer retaining plate .

- Press Presser and Winder key ,

and the sewing machine stops and returns to the normal mode.

- Depress the pedal and the sewing machine stops while the bobbin thread winding mode stays as it is. Use this way when winding bobbin thread around plural bobbins.

### (2) Adjusting the bobbin winding amount

To adjust the winding amount of the bobbin thread, loosen the setscrew ② and move the bobbin winding lever ① to the direction of A or B. Then, tighten the setscrew ②.

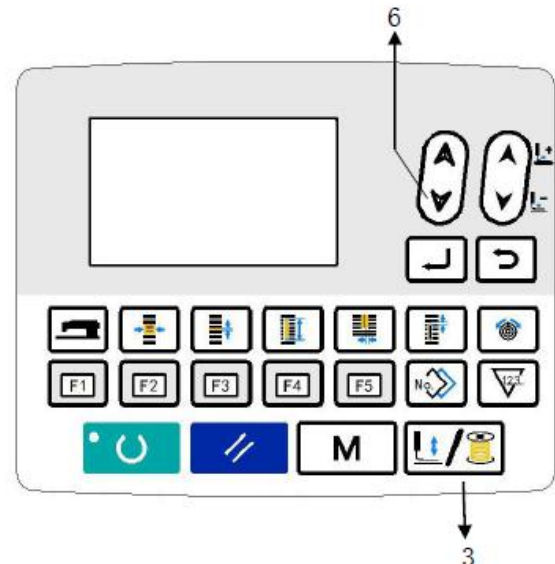
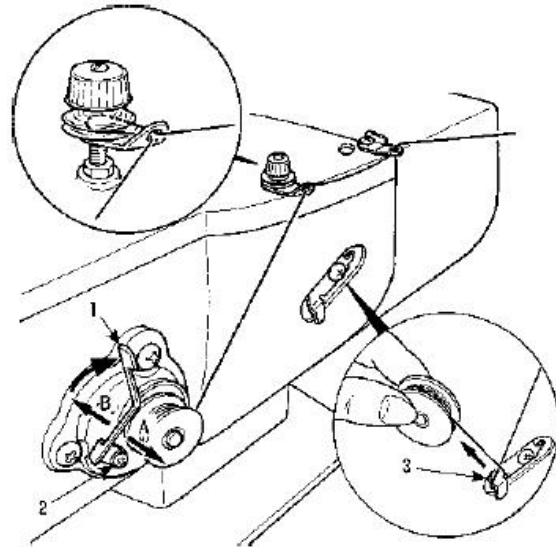



Direction A: Decrease  
Direction B: Increase

## 9. Using the counter

### (1) Setting procedure of the counter value

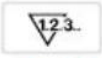
#### 1) Call counter setting screen

When Counter key **18**  is pressed under the input mode where Set Ready LED **20** goes out, the counter screen A for setting the counter is displayed. Counter value can only be set under the input mode. In sewing mode, press Ready key

**2**  to change over the mode to input mode.

#### 2) Select the counter type

Press Item Select key **6**  to display the icon B indicating the counter type in reverse video. Press

Data Change key **7** , and select the proper counter from the following counter types.



#### 3) Change the counter set value

Press Item Select key **6**  to display the set value C of the counter in reverse video. Press Data Change

Key **7**  to input the set value.

#### 4) Change the existing counter value

Press Item Select key **6**  to display the current value D of the counter in reverse video. Press Reset key

**3**  and the value on the way of counting can be cleared. In addition, Data Change key **7**  can also be used to edit the numerical value.

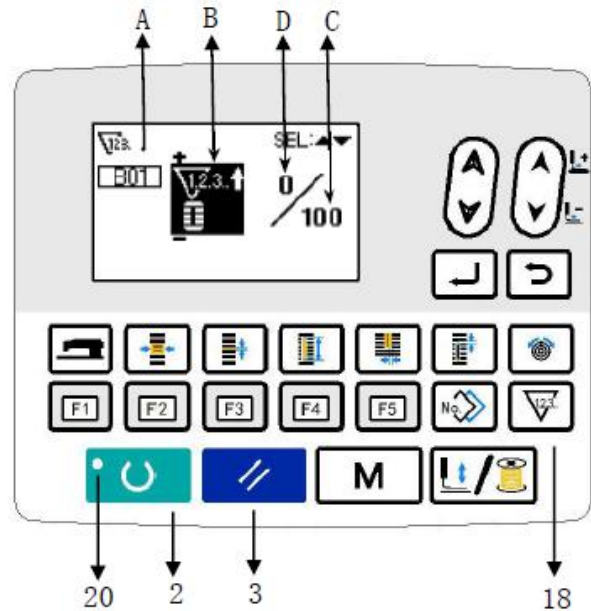

## (2) Counter type



### ① Sewing up counter

Each time the sewing of one shape is performed, the existing value is counted up.  
Existing value and counter setting

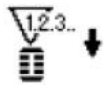

### ② Sewing down counter

Each time the sewing of one shape is performed, the existing value is counted down.  
When the existing value reaches "0", count-up screen is displayed.

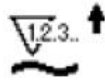

### ③ Pcs. No. up counter

Each time one cycle or one continuous stitching is performed, the existing value is counted up. When the existing value is equal to the set value, count-up screen is displayed.

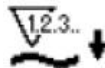

### ④ Pcs. No. down counter

Each time one cycle or one continuous stitching is performed, the existing value is counted down. When the existing value reaches "0", count-down screen is displayed.



### ⑤ Counter not used

## (3) Count-up releasing procedure

When count-up condition is reached during sewing work, the count-up screen E is displayed.

Press Reset key  to reset the counter,

and the mode returns to the sewing mode. Then the counter starts counting again.

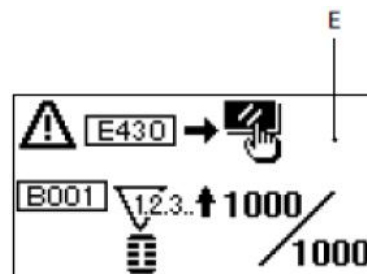

## 10. Using the initial value management

This sewing machine has the initial value for the most appropriate sewing shapes (31 shapes). → Refer to “[XI. Table of initial value data for each shape](#)” p.76. When creating new sewing data, it is convenient to create it by copying the initial value.

### 1) Set the mode to the input mode

Under the input mode where Set Ready LED  goes out, pattern can be changed. In sewing mode,

press Ready key  2) to change over the

mode to input mode.

### 2) Call initial value mode

The currently selected pattern No. A is displayed.

Press Data Change key  7) to select initial

value pattern .

### 3) Select shape

The shape selection screen B is displayed to show the currently-selected shape C. Select shape C to

sew with Data Change key  7). It is possible

to select the shape from 12 shapes at the time of your purchase. However, you can select the shape from up to 31 shapes by increasing the shape selection level (K004).

→ Refer to “[V-21. Method of changing memory switch data](#)” (P.51).

### 4) Perform trial sewing

Press Ready key  2) to set the mode to

the sewing mode. Then the selected pattern can be sewn.

※ The initial-value pattern can be edited only with respect to the data on needle thread tension and sewing speed. Be aware that the edited data will return to the initial value(s) when the pattern shape is changed or the pattern is re-called.

### 5) Copy initial value pattern

Copy the pattern which has been selected and

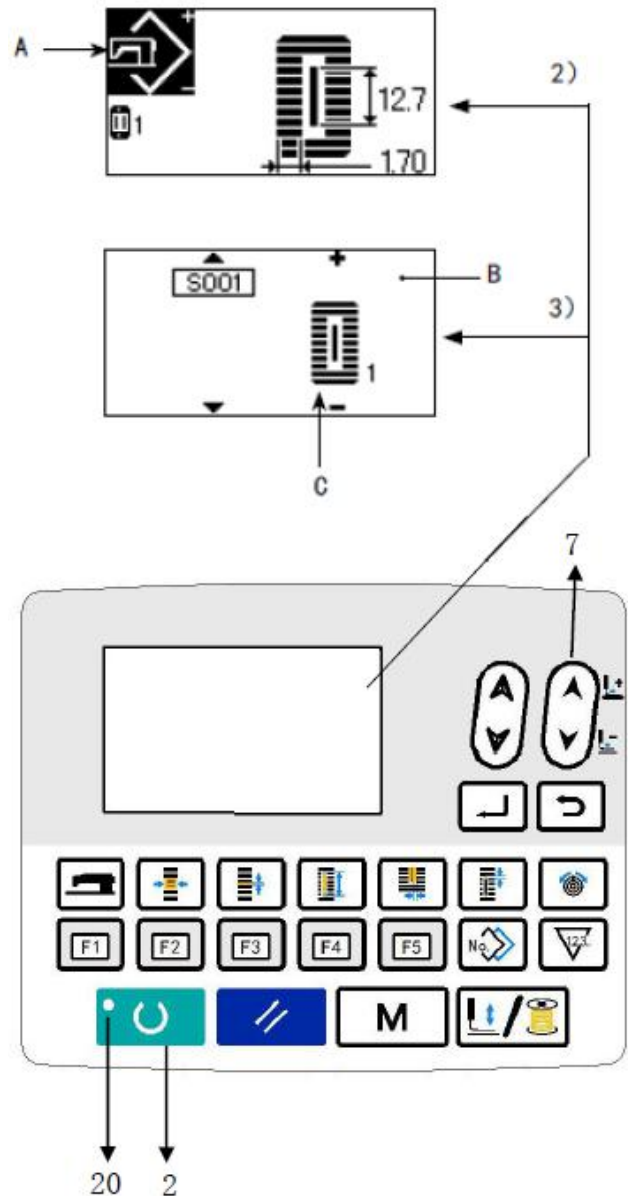

confirmed through the steps above to the normal pattern. Refer to → [“V-14. Copying sewing pattern”](#) P.39 for the copying procedure.

## 11. Changing sewing data



### (1) Initial sewing data when purchasing

Patterns from 1 to 10 have been already registered at the time of your purchase. Only the initial values of different square types for cloth cutting length are input into the sewing data. → Refer to “XI. Table of initial value data for each shape” p.76 for initial values of square types.

Pattern No.	Cloth cutting length (mm)
1	6.4mm
2	9.5mm
3	11.1mm
4	12.7mm
5	14.3mm
6	15.9mm
7	17.5mm
8	19.1mm
9	22.2mm
10	25.4mm

### (2) Changing method of sewing data

#### 1) Set the mode to the input mode

Under the input mode where Set Ready LED  goes out, sewing data can be changed. In sewing mode, press Ready key  to change over the mode to input mode.

#### 2) Call sewing data editing screen

Press Edit key , and the sewing data edit screen A for the currently selected pattern No. is displayed.

#### 3) Select sewing data to be changed

Press Item Selection key , and select the data item to be changed. Data item which is not used according to the shape and data item which is set without function are skipped and not displayed. → Refer to “V-12. Method of setting sewing data with/without edit” p.32.

#### 4) Change data

For the sewing data, there are data item that changes numerical value and data item that selects the icon.

No. such as  is attached to the data item which changes numerical value. Increase or decrease the set

value with Data Change key  to change the value.

No. such as  is attached to the data item which selects icon. Icons can be selected with DATA

CHANGE key .

→ For the details of sewing data, refer to “V-13. Sewing data table” p.33.

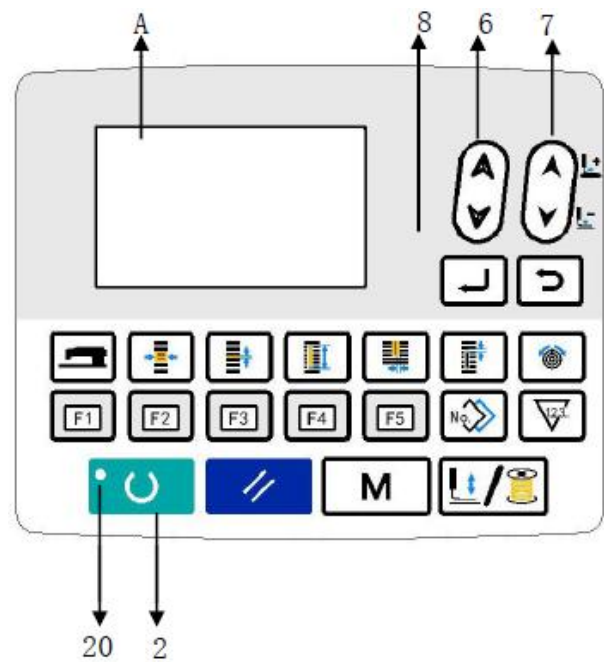



## 12. Method of setting sewing data with/without edit

This sewing machine has been set so as not to be capable of editing sewing data items which are less frequently used at the time of your purchase. When you desire to set the data more closely in accordance with the sewing products, set the sewing data item to the edit possible state and use the machine.

\* For the setting of “with/without edit” for the sewing data, when S052 right parallel section tension is set to “without edit”, sewing is performed with the data of S051 left parallel section tension. When S056 2<sup>nd</sup> bar-tacking tension is set to “without edit”, sewing is performed with the data of S055 1<sup>st</sup> bar-tacking section.

When the sewing data items other than the above ones are set to “without edit”, the data to be referred are the initial value data.

### 1) Set the mode to the input mode

Under the input mode where Set Ready LED 20 goes out, data setting is enabled. In sewing mode, press 2  to change over the mode to input mode.

### 2) Call sewing data with/without edit changeover screen

Press Mode key 4 . Select “05 Select to edit sewing data”. The data edit enable/disable changeover screen A or B are displayed.

### 3) Select sewing data to be changed over

Press Item Selection key 6 , and select data item C to be changed over. At this moment, only items which could be changed over could be selected.

### 4) Changeover of with/without edit



When Data Change key 7  is pressed, the icon display C for the currently-selected sewing data is changed over.

ON: With edit

OFF: Without edit

Return to step 3), and plural sewing data items can be changed over.

### 5) Save set data

When Return key 9  is pressed, the changed-over state is saved and the screen returns to the mode screen. When Reset key 3  is pressed, the screen returns to the previous screen.

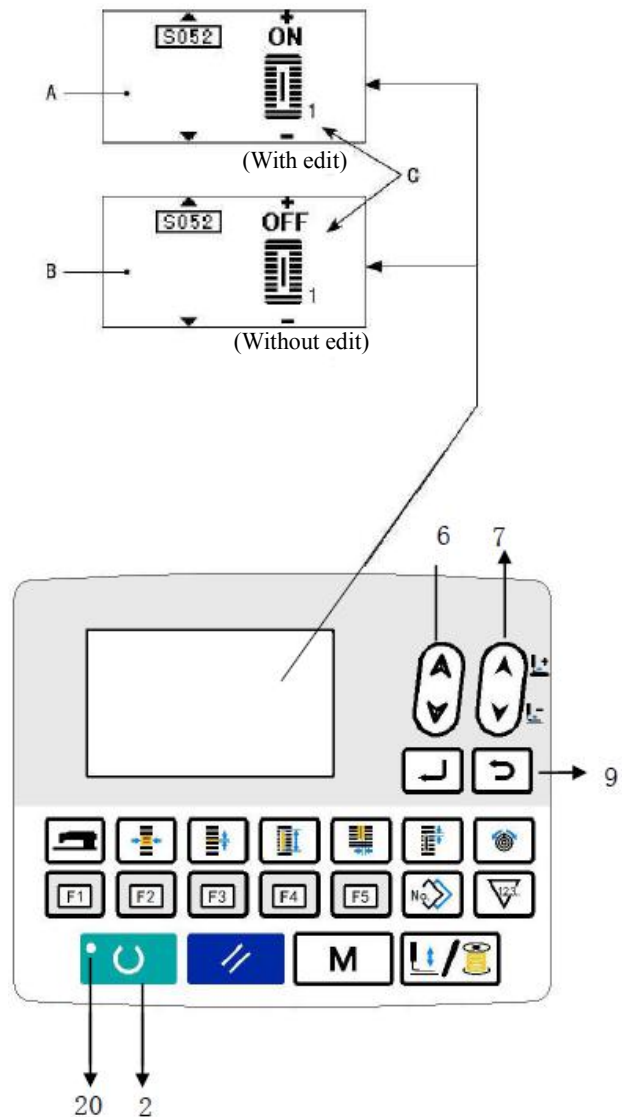















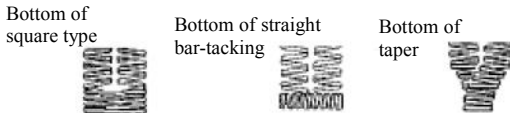

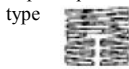





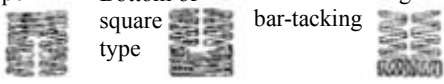

### 13. Sewing data list

☆Sewing data are those that could be input into 99 patterns from 1-99. Such sewing data can be input into each pattern.

When purchasing, the sewing machine has been set in the state that the data which is necessary to set “With/without edit” cannot be selected. Change the function to “With edit” if necessary for the use.

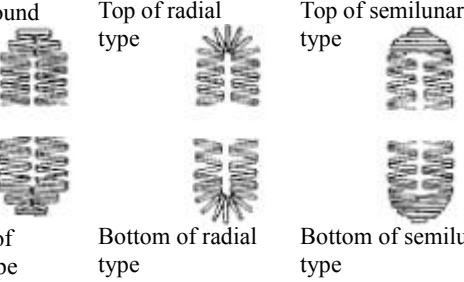
Refer to “V-12. Method of setting sewing data with/without edit” p.32.























No.	Item	Setting range	Edit unit	Remarks
S001	<p><b>Sewing shape</b> This item selects the shape from the sewing machine's 31 sewing shapes.</p>  <p>Refer to “II-2. Standard sewing shape list”</p> <p>※ Only 12 kinds of standard sewing shapes can be selected at the time of your purchase. When increasing the number of shapes, set the K004 sewing shape selection level of memory switch data. → Please refer to “V-22.List of memory switch data” p.52.</p>	1 ~ 31	1	-
S002	<p><b>Cloth cutting length</b> This item sets the length of cloth that is cut by cloth cutting knife. However, for bar-tack shape (Nos. 27, 28, 29, and 30 of S001), only sewing length can be set. After setting the <b>U019 Function of plural motions of cloth cutting knife</b> of memory switch data as active, you can make knife act as per the knife size set in the item <b>U018 Cloth cutting knife size</b> to cut the sewing products. →Please refer to “V-22.List of memory switch data” p.52.</p> 	3.0 ~ 120.0	0.1mm	-
S003	<p><b>Right knife groove width</b> This item sets the clearance between cloth cutting knife and right parallel section.</p> 	-2.00 ~ 2.00	0.05mm	-
S004	<p><b>Left knife groove width</b> This item sets the clearance between cloth cutting knife and left parallel section.</p> 	-2.00 ~ 2.00	0.05mm	-
S005	<p><b>Left overedging width</b> This item sets the overedging width of left parallel section.</p> 	0.10 ~ 5.00	0.05mm	-
S006	<p><b>Ratio of right and left shapes</b> This item sets enlargement/reduction ratio of right side shape making the knife position as the center.</p> 	50 ~ 150	1%	-
S007	<p><b>Pitch at parallel section</b> This item sets sewing pitch of left and right parallel sections.</p> 	0.200 ~ 2.500	0.025mm	-
S008	<p><b>2<sup>nd</sup> bar-tacking length</b> This item sets length of bar-tacking on the front side.</p> <p>Bottom of square type      Bottom of straight bar-tacking      Bottom of taper</p>  	0.2 ~ 5.0	0.1 mm	-
S009	<p><b>1<sup>st</sup> bar-tacking length</b> This item sets length of bar-tacking on the rear side.</p> <p>Top of square type</p>  	0.2 ~ 5.0	0.1 mm	-

No.	Item	Setting range	Edit unit	Remarks
S010	<p><b>Correction of right bar-tacking width</b> This item adjusts right-side outer shape of bar-tacking section and the overedging section. Both 1<sup>st</sup> and 2<sup>nd</sup> bar-tacking sections are corrected.</p> <p>Top of square type      Bottom of square type      Bottom of straight bar-tacking</p>  	-1.00 ~ 1.00	0.05 mm	-
S011	<p><b>Correction of left bar-tacking width</b> This item adjusts left-side outer shape of bar-tacking section and the overedging section.</p> <p>Top of square type      Bottom of square type      Bottom of straight bar-tacking</p>  	-1.00 ~ 1.00	0.05mm	-
S012	<p><b>Taper bar-tacking offset, left</b> This item sets length of bar-tacking section which forms the taper bar-tacking shape.</p> 	0.00 ~ 3.00	0.05mm	*1
S013	<p><b>Taper bar-tacking offset, right</b> This item sets length of bar-tacking section which forms the taper bar-tacking shape.</p> 	0.00 ~ 3.00	0.05mm	*1
S014	<p><b>Eyelet shape length</b> This item sets the upper side length from the center of eyelet of eyelet shape.</p> 	1.0 ~ 10.0	0.1mm	*1
S015	<p><b>Number of stitches of eyelet shape</b> This item sets number of stitches in the upper 90° of eyelet shape.</p> 	1 ~ 8	1	*1
S016	<p><b>Eyelet width</b> This item sets crosswise size of the inside of eyelet shape. Actual needle entry point is the dimension to which S04 Knife groove left width is added.</p> 	1.0 ~10.0	0.1mm	*1
S017	<p><b>Eyelet length</b> This item sets lengthwise size of the inside of eyelet shape.</p> 	1.0 ~ 10.0	0.1mm	*1
S018	<p><b>Round-type shape length</b> This item sets upper length from the center of round type shape.</p> <p>Top of round type      Top of radial type      Top of semilunar type</p>   <p>Bottom of round type      Bottom of radial type      Bottom of semilunar type</p>	1.0 ~ 5.0	0.1mm	*1
S019	<p><b>Number of stitches of radial shape</b> This item sets number of stitches in the upper 90° of radial shape.</p> 	1 ~ 8	1	*1
S020	<p><b>Reinforcement of radial shape</b> This item sets whether to conduct reinforcement stitching of radial shape.</p>  	-	-	*1, *2

\*1: Displayed according to the shape.

\*2: Displayed when it is set to with edit. Refer to “V-12. Method of setting sewing data with/without edit” p.32.















\*3: Displayed when the function is selected.

No.	Item	Setting range	Edit unit	Remarks
S021	<p><b>Reinforcement of radial shape</b> This item sets sewing pitch of bar-tacking section.</p>  <p>Top of square type  Top of round type  Top of semilunar type </p> <p>Bottom of square type  Bottom of round type  Bottom of semilunar type  Bottom of straight bar-tacking  Bottom of taper bar-tacking </p>	0.200 ~ 2.500	0.025 mm	-
S022	<p><b>1<sup>st</sup> clearance</b> This item sets the clearance between 1<sup>st</sup> bar-tacking and knife groove. This item is applied to all shapes.</p> 	0.0 ~ 4.0	0.1 mm	-
S023	<p><b>2<sup>nd</sup> clearance</b> This item sets the clearance between 2<sup>nd</sup> bar-tacking and knife groove. This item is applied to all shapes.</p> 	0.0 ~ 4.0	0.1 mm	-
S031	<p><b>Single/double stitching</b> This item selects single or double stitching.</p>  Single stitching  Double stitching	-	-	-
S032	<p><b>Double stitching cross selection</b> This item selects overlapping stitching or cross stitching at the needle entry of parallel section when setting double stitching.</p>  Double stitching  Cross stitching	-	-	*3
S033	<p><b>Correction of double stitching width</b> This item sets amount to narrow overedging width of 1<sup>st</sup> cycle when setting double stitching.</p> 	0.0 ~ 2.0	0.1mm	*3
S034	<p><b>Number of basting times</b> This item sets number of basting times.</p>  Without basting  With basting (setting times)	0 ~ 9	1	-
S035	<p><b>Basting pitch</b> This item sets pitch at the time of basting.</p> 	1.0 ~ 5.0	0.1mm	*3
S036	<p><b>Rolling length of basting</b> This item sets rolling length of needle thread when performing basting.</p> 	2.0 ~ 20.0	0.1mm	*3
S037	<p><b>Rolling pitch of basting</b> This item sets rolling pitch of needle thread when performing basting.</p> 	0.2 ~ 5.0	0.1 mm	*3
S038	<p><b>Rolling width of basting</b> This item sets rolling width of needle thread when performing basting.</p> 	0.0 ~ 4.0	0.1mm	*3
S039	<p><b>Lengthwise compensation of needle entry of basting</b> This item sets the amount to move needle entry position back and forth when performing basting more than two cycles.</p> 	0.0 ~ 2.5	0.1 mm	*2, *3

\*1: Displayed according to the shape.

\*2: Displayed when it is set to with edit. Refer to “V-12. Method of setting sewing data with/without edit” p.32.















\*3: Displayed when the function is selected.

No.	Item		Setting range	Edit unit	Remarks
S040	<b>Crosswise compensation of needle entry of basting</b> This item sets the amount to move needle entry position to the right or left when performing basting more than two cycles.		0.0 ~ 1.0	0.1 mm	*3
S041	<b>Compensation of left side position of basting</b> This item sets the amount to move the sewing reference position of basting from the center of left overedging to the right or left.		2.0 ~ 2.0	0.1 mm	*2, *3
S042	<b>Compensation of right side position of basting</b> This item sets the amount to move the sewing reference position of basting from the center of right overedging to the right or left.		-2.0 ~ 2.0	0.1 mm	*2, *3
S044	<b>Setting basting speed</b> This item sets the speed of basting.		400 ~ 4200	100sti / min	*3
S051	<b>Left parallel section tension</b> This item sets needle thread tension at left parallel section.		0 ~ 200	1	-
S052	<b>Right parallel section tension</b> This item sets needle thread tension at right parallel section.		0 ~ 200	1	*2
S053	<b>Left parallel section tension (1<sup>st</sup> cycle of double stitching)</b> This item sets needle thread tension at left parallel section of 1 <sup>st</sup> cycle at the time of double stitching.		0 ~ 200	1	*2, *3
S054	<b>Right parallel section tension (1<sup>st</sup> cycle of double stitching)</b> This item sets needle thread tension at right parallel section of 1 <sup>st</sup> cycle at the time of double stitching.		0 ~ 200	1	*2, *3
S055	<b>1<sup>st</sup> bar-tacking section tension</b> This item sets needle thread tension at 1 <sup>st</sup> bar-tacking section.		0 ~ 200	1	-
S056	<b>2<sup>nd</sup> bar-tacking section tension</b> This item sets needle thread tension at 2 <sup>nd</sup> bar-tacking section.		0 ~ 200	1	*2
S057	<b>Setting of needle thread tension at the start of sewing</b> This item sets needle thread tension of tie stitching at the start of sewing.		0 ~ 200	1	-
S058	<b>Setting of needle thread tension of basting</b> This item sets needle thread tension of basting.		0 ~ 200	1	*3
S059	<b>ACT timing adjustment at the start of 1<sup>st</sup> bar-tacking</b> This item adjusts needle thread tension output start timing at 1 <sup>st</sup> bar-tacking section.		5 ~ 5	1 stitch	*2
S060	<b>ACT timing adjustment at the start of right overedging</b> This item adjusts needle thread tension output start timing at right overedging section.		5 ~ 5	1 stitch	*2

\*1: Displayed according to the shape.

\*2: Displayed when it is set to with edit. Refer to "V-12. Method of setting sewing data with/without edit" p.32.







\*3: Displayed when the function is selected.

No.	Item	Setting range	Edit unit	Remarks
S061	<b>ACT timing adjustment at the start of 2<sup>nd</sup> bar-tacking</b> This item adjusts needle thread tension output start timing at 2 <sup>nd</sup> bar-tacking section.	 -5 ~ 5	1 stitch	*2
S062	<b>Number of stitches for bar-tacking at the start of sewing</b> This item sets number of stitches of bar-tacking at the start of sewing.	 0 ~ 8	1 stitch	-
S063	<b>Sewing pitch for bar-tacking at the start of sewing</b> This item sets sewing pitch of bar-tacking at the start of sewing.	 0.00 ~ 0.70	0.05 mm	*2
S064	<b>Bar-tacking width at the start of sewing</b> This item sets bar-tacking width at the start of sewing.	 0.0 ~ 3.0	0.1 mm	-
S065	<b>Lengthwise compensation of bar-tacking at the start of sewing</b> This item sets start position of bar-tacking in lengthwise direction at the start of sewing.	 0.0 ~ 5.0	0.1 mm	*2
S066	<b>Crosswise compensation of bar-tacking at the start of sewing</b> This item sets start position of bar-tacking in crosswise direction at the start of sewing.	 0.0 ~ 2.0	0.1 mm	*2
S067	<b>Bar-tacking width at the end of sewing</b> This item sets tie stitching width at the end of sewing.	 0.1 ~ 1.5	0.1 mm	-
S068	<b>Number of stitches of bar-tacking at the end of sewing</b> This item sets number of stitches of bar-tacking at the end of sewing.	 0 ~ 8	1	-
S069	<b>Lengthwise compensation of bar-tacking at the end of sewing</b> This item sets start position of bar-tacking in lengthwise direction at the end of sewing.	 0.0 ~ 5.0	0.1 mm	*2
S070	<b>Crosswise compensation of bar-tacking at the end of sewing</b> This item sets start position of bar-tacking in crosswise direction at the end of sewing.	 0.0 ~ 2.0	0.1 mm	*2
S081	<b>Knife motion</b> This item sets "with/without motion" of normal cloth cutting knife.	 Normal knife motion OFF	 Normal knife motion ON	-
S083	<b>Knife motion at 1<sup>st</sup> cycle of double stitching</b> This item sets "with/without motion" of cloth cutting knife at 1 <sup>st</sup> cycle when double stitching is performed.	 Normal knife motion OFF	 Normal knife motion ON	*2, *3

\*1: Displayed according to the shape.

\*2: Displayed when it is set to with edit. Refer to "V-12. Method of setting sewing data with/without edit" p.32.

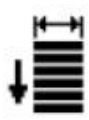
\*3: Displayed when the function is selected.

No.	Item		Setting range	Edit unit	Remarks
S084	<p><b>Maximum speed limitation</b></p> <p>This item sets max. speed limitation of the sewing machine.</p> <p>The maximum value of data edit is the prescribed speed of maximum speed limitation of the memory switch data K007. → Please refer to “V-22.List of memory switch data” p.52.</p>		400 ~ 4200	100sti/min	-
K001	<p><b>Pitch of advancing</b></p> <p>This item sets sewing pitch of advancing side of bar-tacking shape (Shape Nos. 27, 28, 29 and 30 of S001).</p>		0.200 ~ 2.500	0.025mm	-
K002	<p><b>Width of advancing</b></p> <p>This item sets sewing width of advancing side of bar-tacking shape (Shape Nos. 27, 28, 29 and 30 of S001).</p>		0.1 ~ 10.0	0.05mm	-
K003	<p><b>Pitch of returning</b></p> <p>This item sets sewing pitch of returning side of bar-tacking shape (Shape Nos. 27, 28, 29 and 30 of S001).</p>		0.200 ~ 2.500	0.025mm	-
K004	<p><b>Returning width</b></p> <p>This item sets sewing Returning width side of bar-tacking shape (Shape Nos. 27, 28, 29 and 30 of S001).</p>		0.1 ~ 10.0	0.05mm	-
K005	<p><b>Presser foot pressure</b></p> <p>This item sets the pressure of clamping the cloth. When the set value is 25, the presser foot pressure is approximately 4kg. When the set value is 80, the presser foot pressure is approximately 10kg.</p>		20 ~ 80	1	-

## 14. Copying sewing data

Data of pattern No. which has been already registered can be copied to pattern No. which has not been used. Overwriting copy of the pattern is prohibited. When you desire to overwrite, perform it after erasing the pattern once.

### 1) Set the mode to the input mode

Under the input mode where Set Ready LED  goes out, copying is enabled. In sewing mode,

press Ready key  to change over the mode to input mode.

### 2) Select pattern No. of copy source

Press Item Selection key , and select the source pattern No.

→ Refer to “V-5. Selecting pattern” P.24.

When creating new pattern data, it is convenient to copy the initial value pattern.

→ Refer to “V-10. Using the initial value pattern” P.30.

### 3) Call copy screen

Press Copy key , and copy screen A will be displayed.

### 4) Select pattern No. of copy destination.

Pattern No. B which is not used is displayed. Press

Data Change key  to select a No. to be used for copying.

If you want to erase the pattern, select the garbage can .

### 5) Start Copying

Press Ready key  to start copying. The pattern No. which is created by copying returns to the input screen in the state of being selected.

Press Reset key , and the screen returns to previous one without copying.

※ Cycle data and continuous stitching data can be copied by the same method.

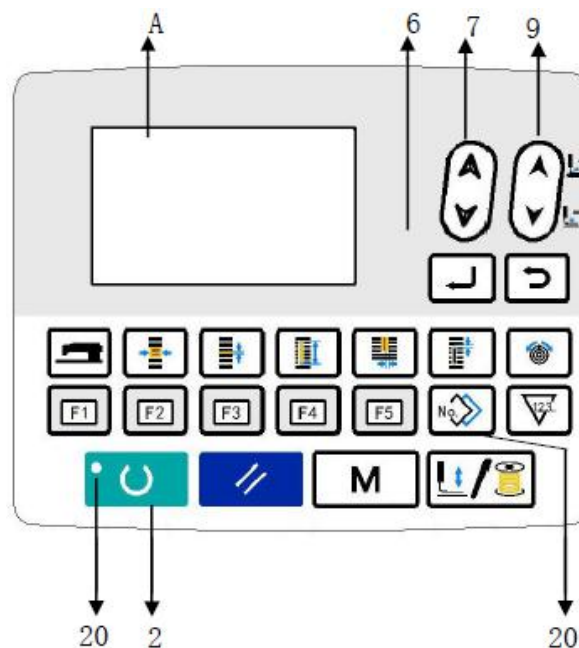





## 15. Edit/check the data other than sewing data

The screen for editing/checking the various data is invoked by selecting the menu on the mode screen.

### 1) Set the mode to the input mode

Under the input mode where Set Ready LED 20 goes out, the mode screen can be invoked. In sewing mode, press Ready key 2  to change over the mode to input mode.

### 2) Call mode screen

Press Mode key 4  to display the mode screen (operator level).

Press Mode key for 3 seconds 4  and then mode screen (maintenance personnel level) will be displayed.

On each level mode screen, the menu items listed in the table below are displayed.

Display level	Menu on the mode screen
Operator level	Memory switch 1 Version display Communication Registration of parameter key Selection of editing sewing parameter
Maintenance personnel level	Check program Adjust pedal depression value Adjustment of contrast Memory switch 2

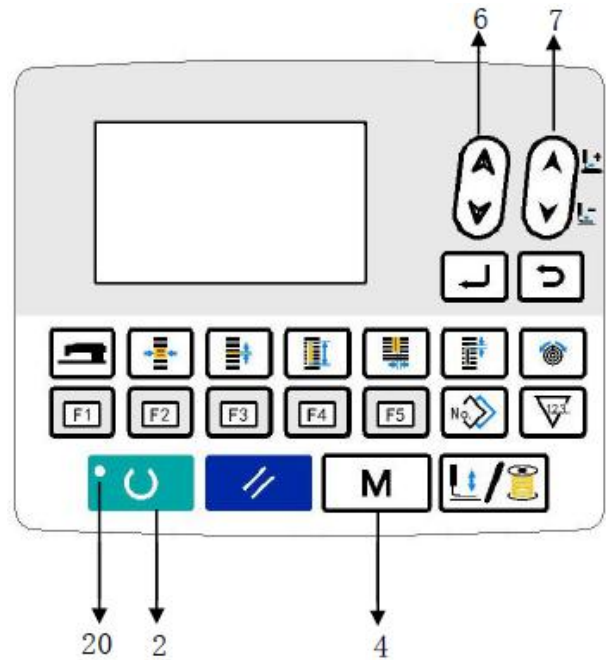

### 3) Selecting the menu

Items which can be registered on the key are displayed. Press Item Selection key  to select the menu.

After Edit key  is pressed during the menu selection, the following screens can be invoked.

1. Memory switch 1  
Refer to “V-21. Method of changing memory switch data” P.51 for details.
2. Version display  
Version of the system software is displayed.
3. Communication  
Refer to “V-26. Communication” P.58 for details.
4. Registration of parameter key  
Refer to “V-16. Using parameter register key” P.42 for details.
5. Selection of editing sewing parameter  
Refer to “V-12. Method of setting sewing data with/without edit” P.32 for details.
6. Check program  
Refer to Service Manual for details.
7. Adjust pedal depression value  
Refer to “V-23. Adjust pedal depression value” P.56 for details.
8. Adjustment of contrast  
Refer to “V-24. Adjust the contrast” P.57 for details.
9. Memory switch 2  
Refer to “V-22. List of memory switch data” P.52 for details.



For the functions which are not described in this manual, only the maintenance personnel is allowed to operate while referring to the Service Manual since operating those functions can lock up the sewing machine or can cause unforeseen accidents.



## 16. Using parameter register key

Register parameters which are frequently used into parameters register key for use.

Registered parameters can be selected by pressing only the parameter register key under the input mode.

### (1) Method of registration

#### 1) Set the mode to the input mode

Under the input mode where Set Ready LED  goes out, setting is enabled. In sewing mode, press Ready key  to change over the mode to input mode.

#### 2) Call parameter register screen

Press Mode key  to display the mode screen. Select the parameter key registration on this screen. Then the parameter registration screen A is displayed.

After Edit key  is pressed, the parameter registration key setting screen is displayed. The parameter registration key setting screen can also be displayed by pressing and holding the parameter registration key to be edited.

#### 3) Select parameter

Item B which can be registered to the key is displayed. Press Item Selection key  to select the item to be registered.

Items which can be registered are sewing data, parameters of memory switches (level 1) and pattern No.

In addition, when garbage can  is selected, the registration could be discharged.



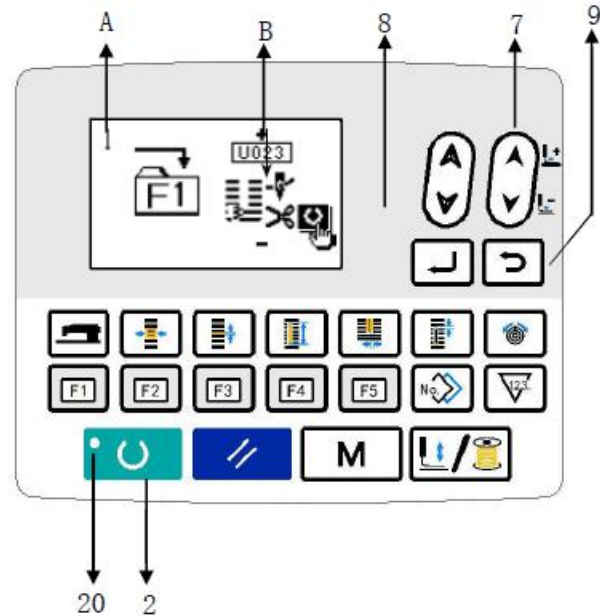

#### 4) Start registration

When Ready key  is pressed, registration starts and the screen returns to the mode screen.

When Return key  is pressed, the screen returns to previous one without registering.



### (2) Register status at the time of purchase

Register key	Registered parameter	
F1	Changeover of single/double stitching	 [S081]
F2	Basting (off/times)	 [S084]
F3	Basting thread tension setting	 [S058]
F4	Plural motions of cloth cutting knife disabled/enabled	 [U019]
F5	Cloth cutting knife size	 [U018]

## 17. Performing continuous sewing

The sewing machine can achieve continuous sewing of plural pattern without raising presser.

The sewing machine can sew the maximum of six types of shapes automatically in one cycle.



Moreover, it can register the maximum of 20 data.

Please copy it before use if required. Refer to “V-14. Copying sewing pattern” P.39.

\*It is necessary to change the parts from the state at the time of your purchase according to the setting conditions.

### (1) Selection of continuous sewing data

#### 1) Set the mode to the input mode

Under the input mode where Set Ready LED  goes out, the continuous-sewing data selection is enabled. In sewing mode, press Ready key  **2**

to change over the mode to input mode.

The continuous sewing data can be selected only in input mode.



#### 2) Call the pattern selection screen

Press Item Selection key  **6**, to select continuous sewing screen A.

#### 3) Selecting continuous sewing data

Press Data Change key  **7**, to select the intended continuous sewing data No. B.

#### 4) Perform sewing

When the continuous sewing data is selected, press the Ready key  **2**, then the Set Ready LED  will light up, indicating that the sewing is enabled.

Continuous stitching data No. 1 only has been registered at the time of your purchase. Sewing status cannot be obtained since the sewing pattern has not been input. Therefore, please refer to (2) **Editing method of continuous sewing data** next page for input.

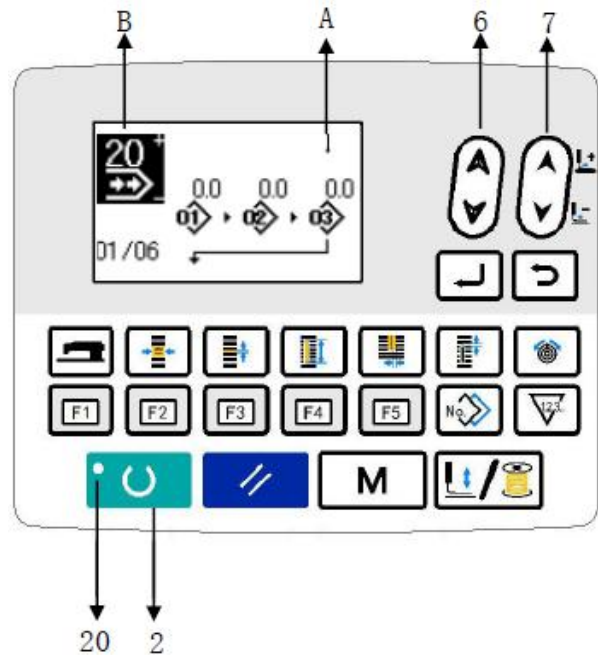

**(2) Editing method of continuous sewing data**

**1) Set the mode to the input mode**

Under the input mode where Set Ready LED ② goes out, the continuous-sewing data entry is enabled. In sewing mode, press Ready key ②  to change over the mode to input mode.

**2) Call the edited continuous sewing data NO.**

When Edit key ③  is pressed, the continuous-sewing data editing display C appears on the screen. The pattern No. D to be sewn is displayed in reverse video. The data is editable in this state.

**3) Select editing point**

Press Edit key ⑥  and then the editing point will move and reverse sequentially. When the editing point is carried to the last piece of data, the additional indication pictograph is displayed if there is an available pattern number. Move forward the editing point from there and then the data name will become the editing point.

In addition, press Edit key on editing point and then it will turn to the state in which the editing point data can be changed.

When the editing point is pattern No., the appended indicator icon will display in selection position and now you can insert the pattern data.

When the editing point is data name, the data name will become editable.

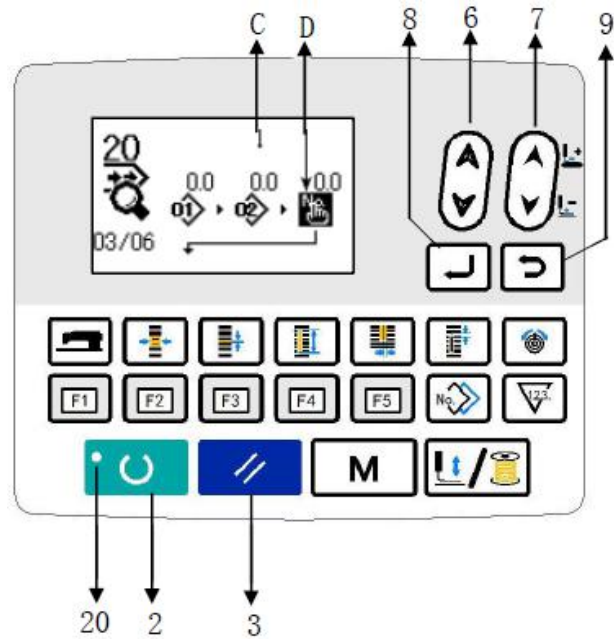

Editing point selection sequence after pressing Item Selection key

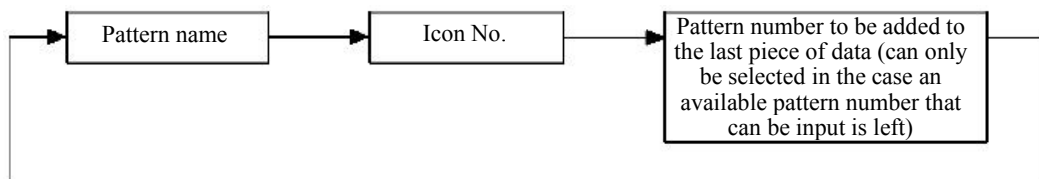

#### 4) Change selected editing point data

Press Data Change key  ⑦ to change editing point data selected.

##### When the editing point is pattern No.

The selected pattern No. is displayed in a state under which it is selectable.

##### When the editing point is at the jump feed

The numerical value can be edited within range of  $\pm 120\text{mm}$ .

In addition, Press Reset key  ③ to delete pattern data of editing point.

Press and hold Reset key  ③ for 1 second to delete all selected pattern data.

Repeat step 3 and 4 for data editing.

#### 5) Cancel insertion of pattern data

Press Reset key  ③ in addition command icon display to cancel insertion of pattern data.



In addition, press Ready key  ② to cancel insertion of pattern data and change over to sewing mode.

Press Return key  ⑨ to cancel insertion of pattern data and change over to input mode.

※ **Input is completed by the steps above. For the continuous stitching, however, input all data within the range of the presser size. Error message will be shown when the data exceeds the range. Be sure to precisely input the presser size.**

→ [Refer to “V-4. Input of the presser type” p.23.](#)

#### 6) Creating new pattern data

Press Copy key  ⑩ to call out copy screen under input mode, and then press Item Selection key  ⑥ to select new-creation icon to conduct the new creation of pattern data.

Press Data Change key  ⑦ while the new-creation icon is being selected, so as to select newly created pattern No.

Further select newly-created pattern No. and press Ready key  ② to conduct new creation of pattern data.

## 18. Performing cycle sewing

The sewing machine can perform the sequential sewing of plural cycle sewing pattern data.

The maximum of 30 patterns can be input, so you can use it when sewing the buttonholes of two or more different sewing products.

Moreover, it can register the maximum of 20 data.

Please copy it before use if required. → Refer to “V-14. Copying sewing pattern” P.39.

### (1) Selection of cycle data

#### 1) Set the mode to the input mode

Under the input mode where Set Ready LED ⑳ goes out, the continuous-sewing data selection is enabled. In sewing mode, press Ready key ㉑  to change over the mode to input mode.

The continuous sewing data can be selected only in data mode.

#### 2) Selection of cycle sewing data

Press Item Selection key ㉒  and then the selected patterns will be displayed sequentially, and after pattern No. is selected, the selected cycle data No. and continuous sewing data No. will be displayed. Now, select the intended sewing data No.

#### 3) Perform sewing

When the continuous sewing data is selected, press the Ready key ㉑ , then the Set Ready LED ㉓ will light up, indicating that the sewing is enabled.

Continuous stitching data No. 1 only has been registered at the time of your purchase. Sewing status cannot be obtained since the sewing pattern has not been input. Therefore, please refer to (2) **Editing method of continuous sewing data** next page for input.

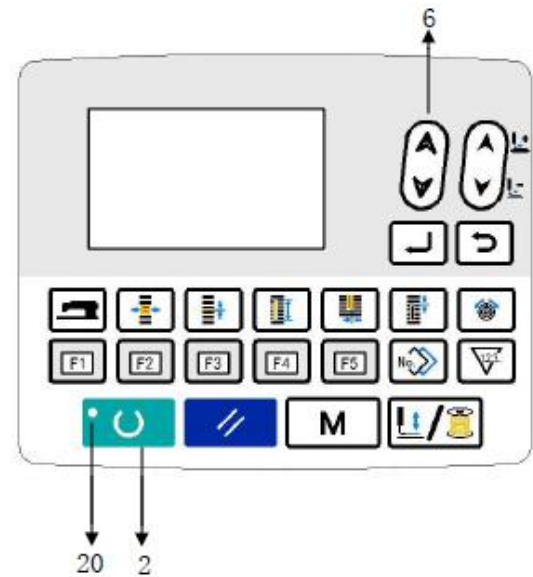

**(2) Editing method of cycle sewing data**

**1) Set the mode to the input mode**

Under the input mode where Set Ready LED 20 goes out, the continuous-sewing data entry is enabled. In sewing mode, press Ready key 2  to change over the mode to input mode.

**2) Set cycle data to editing state**

When Edit key 8  is pressed, the continuous-sewing data editing display C appears on the screen. The pattern No. D to be sewn is displayed in reverse video. The data is editable in this state.

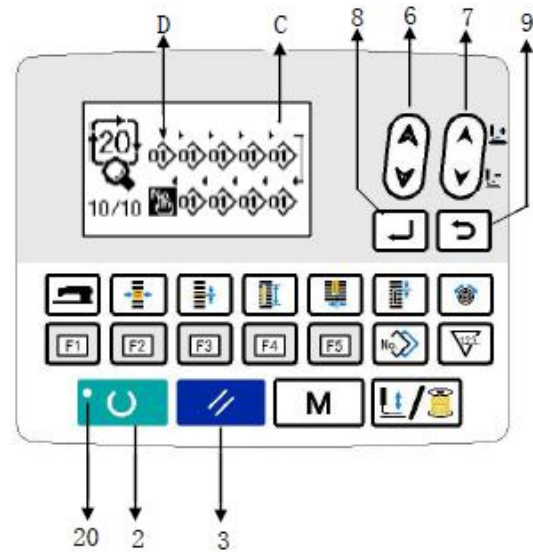

**3) Select editing point**

Press Item Selection key 6  and then the editing point will move and reverse sequentially. When the editing point is carried to the last piece of data, the additional indication pictograph is displayed if there is an available pattern number. Move forward the editing point from there and then the data name will become the editing point.

In addition, press Edit key on editing point and then it will turn to the state in which the editing point data can be changed.

**When the editing point is pattern No.**

The appended indicator icon will display in selection position and now you can insert the pattern data.

**When the editing point is data name**

The data name will become editable.

**Editing point selection sequence after pressing Item Selection key**

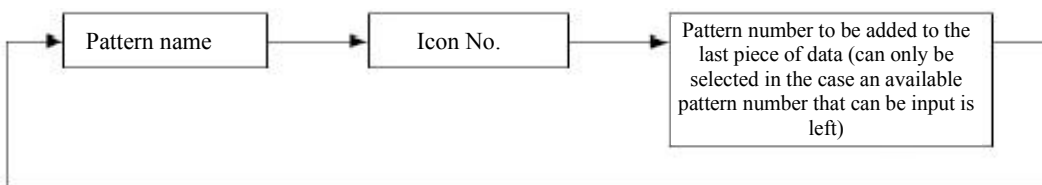



#### 4) Change selected editing point data

Press Data Change key **7**  to change editing point data selected.

The selected pattern No. is displayed in a state under which it is selectable.

In addition, Press Reset key **3**  to delete pattern data of editing point.

Press and hold Reset key **3**  for 1 second to delete all selected pattern data.

Repeat step 3 and 4 for data editing.



#### 5) Cancel insertion of pattern data

Press Reset key **3**  in addition command icon display to cancel insertion of pattern data.

In addition, press Ready key **2**  to cancel insertion of pattern data and change over to sewing mode.

Press Return key **9**  to cancel insertion of pattern data and change over to input mode.

#### 6) Creating new pattern data

Press Copy key **10**  to call out copy screen under input mode, and then press Item Selection key **6**  to select new-creation icon to conduct the new creation of pattern data.

Press Data Change key **7**  while the new-creation icon is being selected, so as to select newly created pattern No.

Further select newly-created pattern No. and press Ready key **2**  to conduct new creation of pattern data.

## 19. Change the name of cycle sewing/continuous sewing data

### 1) Set data name to editing state



Refer to “V-17. Performing continuous sewing” p.43 and “V-18. Performing cycle sewing” p.46a.

### 2) Select data name's editing point

Press Item Selection key **6**  and then the editing point will move sequentially. Text displayed between + and - is the editing point to be selected.

### 3) Change the text in editing point

Press Data Change key **7**  to select the text.

In addition, press Reset key **3**  to delete the selected text. Press and hold Reset key **3**  for 1 second to delete data name.

Repeat step 2) and 3) for data editing.

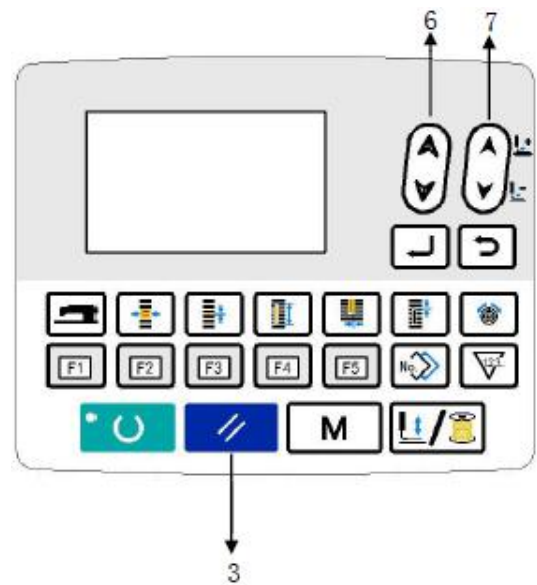



Text available in pattern name  
A-Z, 0-9, ., +, -, /, #, (Blank)

## 20. Description of plural motions of knife



This sewing machine can automatically actuate the knife plural times and sew a buttonhole larger than the size of knife by setting the size of knife attached from the operation panel. Set and use this function when sewing various sewing shapes without replacing the knife.

### (1) Setting of plural motions of knife

#### 1) Set the mode to the input mode



Under the input mode where Set Ready LED  goes out, editing of memory switch is enabled. In sewing mode, press Ready key  to change over the mode to input mode.

#### 2) Input the size of knife

Press Mode key  to display memory switch data (level 1) editing screen A. Press Item selection key  to call out  cloth cutting knife size B.

Then press Data Change key  to set the size of knife C attached. For details, refer to [“V-22.List of memory switch data” p.52.](#)

#### 3) Set the plural motions of cloth cutting knife as enabled

Next, press Item Selection key  to call out  cloth cutting knife numerous action function D. Then set the plural motions of knife to

enabled state through Data Change key . For details, refer to [“V-22.List of memory switch data” p.52.](#)

#### 4) Perform sewing

When Ready key  is pressed, the sewing is enabled. At this time, when S002 Cloth cutting length is set to a size larger than U018 Cloth cutting knife size which has been set above, the plural motions of knife is automatically performed for sewing.

\* If a buttonhole smaller than the size of knife attached is desired to be sewn, error 489 will be displayed.

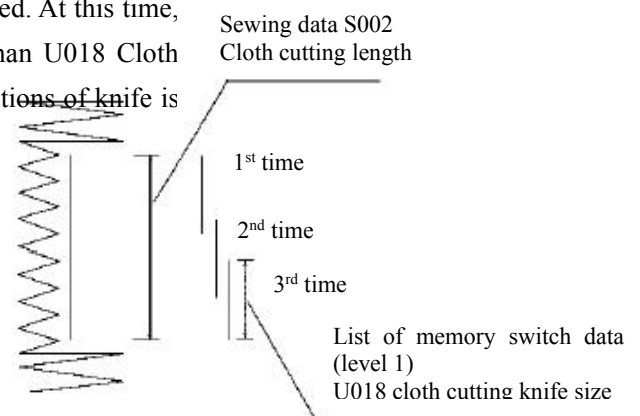
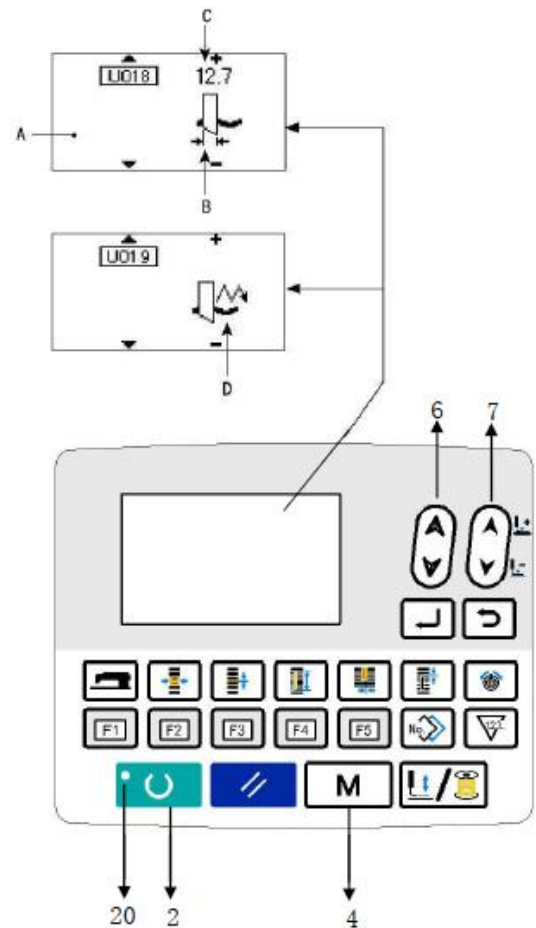

## 21. Changing method of memory switch data

### 1) Set the mode to the input mode

Under the input mode where Set Ready LED **20** goes out, changing of memory switch is enabled. In sewing mode, press Ready key **2**  to change over the mode to input mode.

### 2) Call memory switch data editing screen

Press Mode key **4**  to display the mode screen (operator level).

You can choose memory switch data in this screen (level 1).

Press Mode key **4**  for 3 seconds and then mode screen (maintenance personnel level) will be displayed.

You can choose memory switch data in this screen (level 2).

### 3) Select memory switch data to be changed

Press Item Selection key **6** , and select the data item to be changed.

### 4) Change data

For the memory switch data, there are data item that changes numerical value and data item that selects the icon.

No. such as  is attached to the data item which changes numerical value. Increase or decrease the set

value with Data Change key **7**  to change the value.

No. such as  is attached to the data item which selects icon. Icons can be selected with Data Change

key **7** .



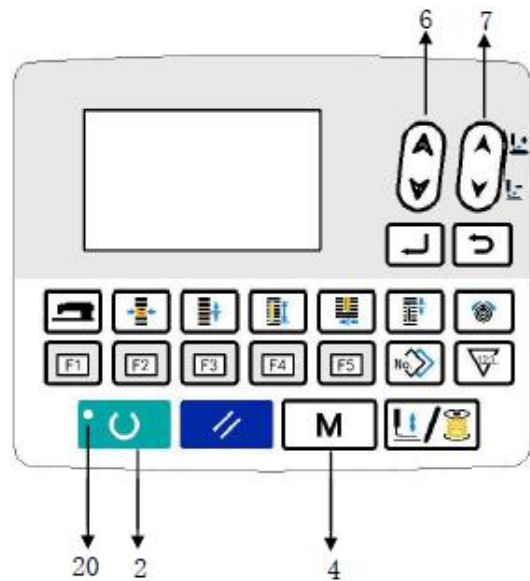









Refer to “[V-22. List of memory switch data](#)” p.52 for → details of memory switch data.

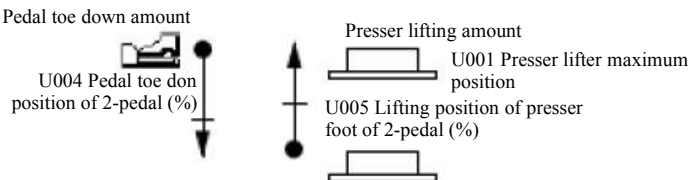



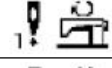
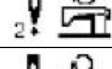
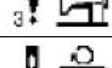
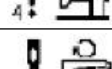
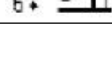
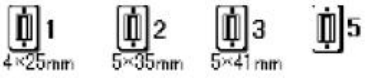











## 22. List of memory switch data

### (1) Level 1







☆Memory switch data (level 1) are the motion data that the sewing machine has in common and the data that operate on all sewing patterns in common.



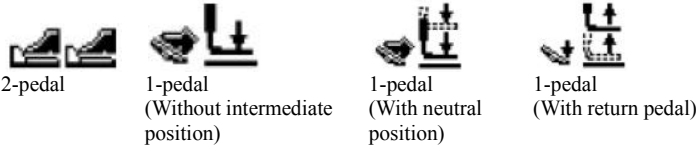

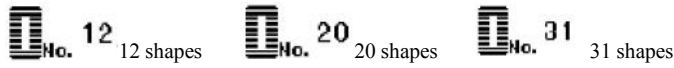
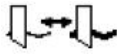

No.	Item		Setting range	Edit unit	Initial value
U001	<b>Presser lifter maximum position</b> Height of maximum position of pedal operation is set.		0 ~ 17.0	0.1 mm	14.0 mm
U002	<b>Presser lifter intermediate position</b> Height of intermediate position of pedal operation is set.		0 ~ 14.0	0.1 mm	6.0 mm
U003	<b>Presser lifter cloth setting position</b> Height of cloth setting position of pedal operation is set.		0 ~ 14.0	0.1 mm	0.0 mm
U004	<b>Pedal toe down position of 2-pedal (%)</b> Operation feeling at the time of 2-pedal is set. Refer to the item below. Refer to the following for details.		5 ~ 95	1%	80 %
U005	<b>Lifting position of presser foot of 2-pedal (%)</b> Operation feeling at the time of 2-pedal is set.  Pedal toe down amount U004 Pedal toe don position of 2-pedal (%)  Presser lifting amount U001 Presser lifter maximum position U005 Lifting position of presser foot of 2-pedal (%)		5~ 95	1%	50 %
U006	Needle thread tension at sewing end setting		0 ~ 200	1	35
U007	Needle thread tension at thread trimming setting		0 ~ 200	1	35
U008	Needle thread tension of basting for sewing together setting		0 ~ 200	1	60
U009	Soft-start speed setting      1 <sup>st</sup> stitch		400 ~ 4200	100 sti/min	800 sti/min
U010	Soft-start speed setting      2 <sup>nd</sup> stitch		400 ~ 4200	100 sti/min	800 sti/min
U011	Soft-start speed setting      3 <sup>rd</sup> stitch		400 ~ 4200	100 sti/min	2000 sti/min
U012	Soft-start speed setting      4 <sup>th</sup> stitch		400 ~ 4200	100 sti/min	3000sti/min
U013	Soft-start speed setting      5 <sup>th</sup> stitch		400 ~ 4200	100 sti/min	4000sti/min
U014	<b>Presser type</b> Please set presser type—Refer to “V-4. Input of the presser type” p.23  		-	-	Type 1
U015	<b>Presser size: width</b> Set U014 presser type as type 5 and then input presser foot width.		3.0 ~ 10.0	0.1 mm	3.0 mm
U016	<b>Presser size: length</b> Set U014 presser type as type 5 and then input presser foot length.		10.0 ~ 150.0	0.5 mm	10.0 mm
U017	<b>Sewing start position (feed direction)</b> Sewing start position corresponding to the presser is set. Set this item when starting position is desired to be shifted due to overlapped section or the like.		2.5 ~ 110.0	0.1 mm	2.5 mm

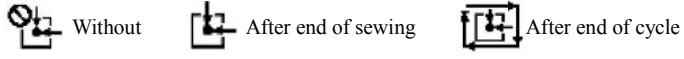
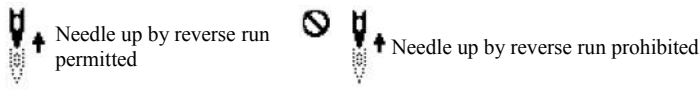
No.	Item	Setting range	Edit unit	Initial value
U018	<b>Cloth cutting knife size</b> Input knife size used. 	3.0 ~ 32.0	0.1mm	32.0mm
U019	<b>Plural motions of cloth cutting knife disabled/enabled</b>  Disabled  Enabled	-	-	Disabled
U020	<b>Thread trimming detection function disabled/enabled</b>  Disabled  Enabled	-	-	Enabled
U021	<b>Selection of presser position when Ready key is on (up/down)</b> Set presser position when Ready key is pressed.  Presser up  Presser down	-	-	Presser up
U022	<b>Selection of presser position at the end of cycle sewing (up/down)</b> This item sets the position of presser at the end of one cycle sewing. (Enabled only for 1-pedal setting)  Presser up  Presser down	-	-	Presser up
U023	<b>Needle thread trimming motion start distance</b> Distance from the start of sewing to the start of needle thread trimmer release motion is input. 	0 ~ 15.0	0.1mm	1.0mm
U024	<b>Bobbin thread trimming motion start distance</b> Distance from the start of sewing to the start of bobbin thread trimmer release motion is input. 	0 ~ 15.0	0.1mm	1.5mm
U025	<b>Counter updating unit</b> Set the unit for updating sewing counting 	1 ~ 30	1	1
U026	<b>Total number of stitches not displayed/displayed</b>  Not displayed  Displayed	-	-	Not displayed
U027	<b>LED light luminance setting</b> 	0 ~ 5	1	5
U500	<b>Language selection</b> The language to be used for the display on the sewing panel is selected. ※The number of selectable languages differs depending on the specifications of the sewing machine at the time of shipment.	-	-	Not selected

**(2) Level 2**

☆Press mode switch for 3seconds to enable editing.

No.	Item	Setting range	Edit unit	Initial value
K001	<p><b>Select pedal</b> Set pedal type Refer to “V-3. Pedal operation method” p.21</p>  <p>2-pedal      1-pedal (Without intermediate position)      1-pedal (With neutral position)      1-pedal (With return pedal)</p>	-	-	1-pedal (Without intermediate position)
K003	<p><b>Function of prohibition of selection presser type</b>      <b>permitted/prohibited</b> Prohibition of change of U014 Kind of presser is set.</p>  <p>Change permitted      Change prohibited</p>	-	-	Change permitted
K004	<p><b>Sewing shape selection level</b> Number of sewing shapes can be increased. (Max. 31 shapes)</p>  <p>No. 12 12 shapes      No. 20 20 shapes      No. 31 31 shapes</p>	-	-	12 shapes
K005	<p><b>Cloth cutting knife power</b> Output power of cloth cutting knife is set. 0: Min. power →3: Max. power</p> 	0 ~ 3	1	3
K006	<p><b>Machine type selection</b> Type of sewing machine head is set. 0: Standard type    1: Dry head type</p> 	0 ~ 1	1	0 (Standard type)
K007	<p><b>Max. sewing speed setting</b> Max. speed of sewing machine can be limited. When K006 machine is set to dry head type, the max. sewing speed is limited to 3300sti/min automatically.</p> 	400 ~ 4200	100sti/min	3600sti/min
K008	<p><b>Needle thread tension deviation compensation</b> Output value of needle thread tension is wholly offset and compensated.</p> 	-30 ~ 30	1	0
K009	<p><b>Output time of needle thread tension changed value</b> When data related to needle thread tension is changed, the changed value is output as long as the set-up time.</p>  <p>Without output      Output of set-up time</p>	0 ~ 20	1s	0s
K010	<p><b>Function of origin retrieval each time</b> Origin retrieval is performed after completion of sewing or completion of cycle.</p>  <p>Without      After end of sewing      After end of cycle</p>	-	-	Without
K011	<p><b>Needle up by reverse run</b>      <b>permitted/prohibited</b> When U001 presser lifter maximum position is set to 14.0 mm or more, motion of needle up by reverse run is automatically performed and the machine stops. Prohibition of the motion can be set.</p>  <p>Needle up by reverse run permitted      Needle up by reverse run prohibited</p>	-	-	Permitted

No	Item	Setting range	Edit unit	Initial value
K018	<b>Pattern selection function under sewing mode disabled/enabled</b>  Disabled  Enabled	-	-	Disabled
K019	<b>Thread trimming during continuous stitching permitted/prohibited</b>  Permitted  Prohibited	-	-	Permitted
K021	<b>Release amount of bobbin thread trimmer at the start of sewing</b> This item sets the amount of releasing the bobbin thread trimmer at the start of sewing. 	0~15	1 pulse	8
K022	<b>Presser lifter speed</b> This item sets presser lifter speed. 	1~3	-	3
K023	<b>Presser abnormality detection position</b> Set the height for detecting height abnormality of E083 presser. When it is set to "0", abnormality detection will not be performed. 	0~10.0	0.1	s.0



### 23. Adjusting pedal depression value

Depress the pedal or input pedal depression value from operation panel to adjust pedal depression value.

1) **Call the pedal depression value adjustment value.**  
 Select "adjust pedal depression value" from the menu on mode screen and press Edit key **③** , and then screen A for adjustment of pedal depression value will be displayed.

2) **Select the registration destination of pedal depression value**

Press Item Selection key **⑥** , the registration destination of current pedal depression value is changed and displayed in reverse video successively. Select the targeted registration destination. The destination can be selected from the five ones shown in the table at the right.





3) **Register pedal depression value**

Press Edit key **③** , to register and display the pedal depression value on the selected destination of registration.

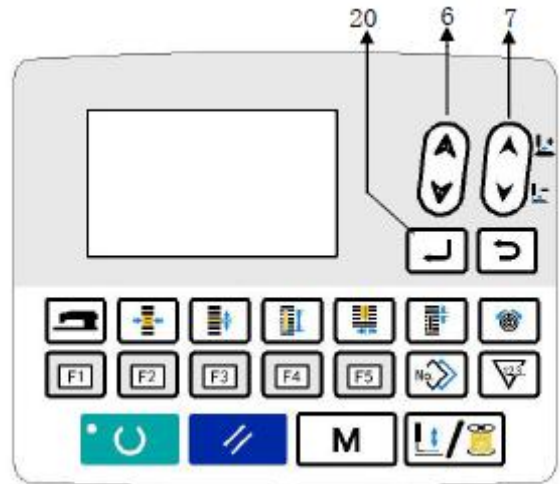
Meanwhile, you can change pedal depression value during the selection of pedal depression value

registered by pressing Data Change key **⑦** . The modifiable range of the pedal depression value is from 0 to 255.



Display	State of pedal to be registered
	Pedal is fully depressed.
	Pedal is depressed to the intermediate position.
	Pedal is depressed slightly.
	Pedal is not depressed.
	Back part of the pedal is depressed.

## 24. Adjusting the contrast

The contrast of the display on the panel can be adjusted in five steps.

### 1) Call contrast adjustment screen

Select the contrast adjustment from the menu on mode screen and press Edit key **8** , and then screen A for contrast adjustment value will be displayed.

### 2) Adjust the contrast

The contrast can be adjusted in five steps from 1 (brightest)

to 4 (darkest) by pressing Data Change key **7** .

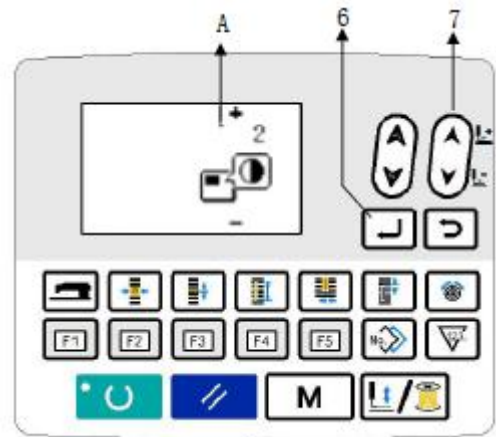

## 25. Setting the key lock

Operation of the data change key can be disabled by setting the key lock. Refer to the Service Manual for how to invoke the key lock setting function and how to set the key lock.

## 26. Communication

The sewing machine may adopt USB flash disk for data input and output.



### 1) Set the mode to the communication mode

In “V-15. Edit/check the data other than sewing data” p.40, refer to model screen to select communication mode.

### 2) Select communication type

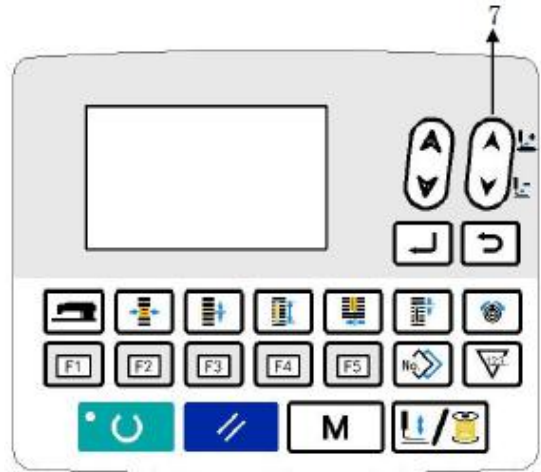
Press Data Change key **7**  to select communication type.





Data Name		Suffix	Data Content
Parameter Data		XXX . EPD	Sewing shape, Cloth cutting length, stitch width, and other inherent sewing data forms compiled.
Icon form data		XXX . VDT	Data of compiled needle entry point.

\* Refer to the service manual for setting method of icon form data.

### 3) Select communication direction

Press Item Selection key **6**  to display icon A indicating communication direction selection.

Press Data Change key **7**  to select communication direction.

: Data shown on the operation panel is written on the USB drive.

: Data stored on the USB drive is read into the operation panel.

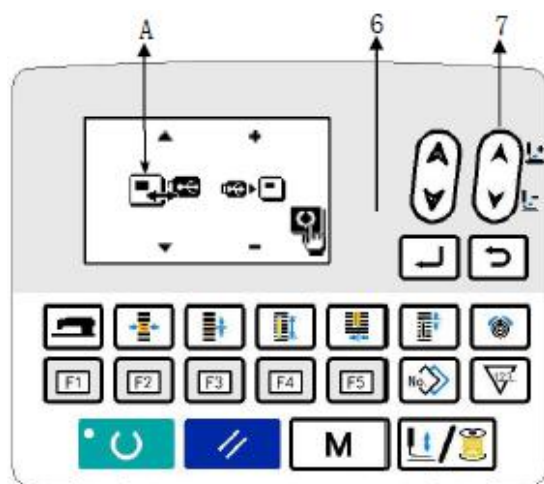

4) **Select No.**

Press Item Selection key **6**  to select file No.  
B to be read.

Press Data Change key **7**  to select file No.  
C to be written.

Press Ready key **2**  to write data.

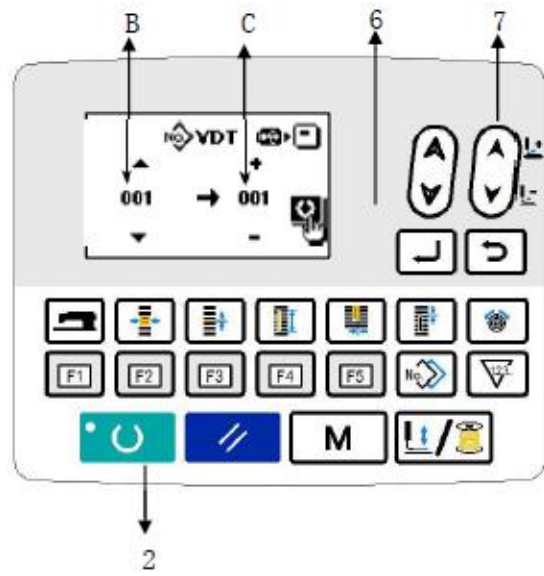

## VI. Maintenance

### 1. Adjusting the needle-to-hook relation

**! Warning** Please turn off the power switch and confirm that the motor has stopped before operation to prevent personal injuries caused by unexpected start.

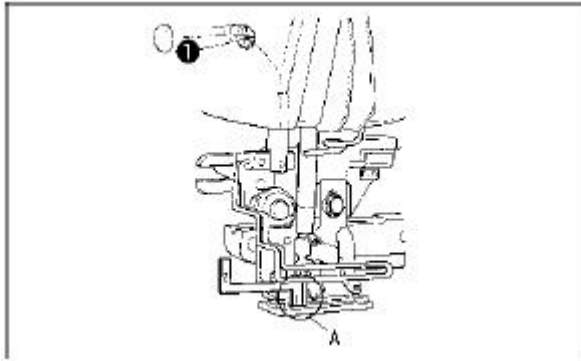

Adjust the needle-to-hook relation when the needle enters the center of the needle hole in the throat plate.

(1) Needle bar height

1) Drop the needle bar to the lowest point.

2) Insert part [1] A of timing gauge into the gap between the bottom end of needle bar and throat plate, where the needle bar touches the timing gauge as shown in the figure.

3) Loosen needle bar connection screw ①, and adjust the height of the needle bar.

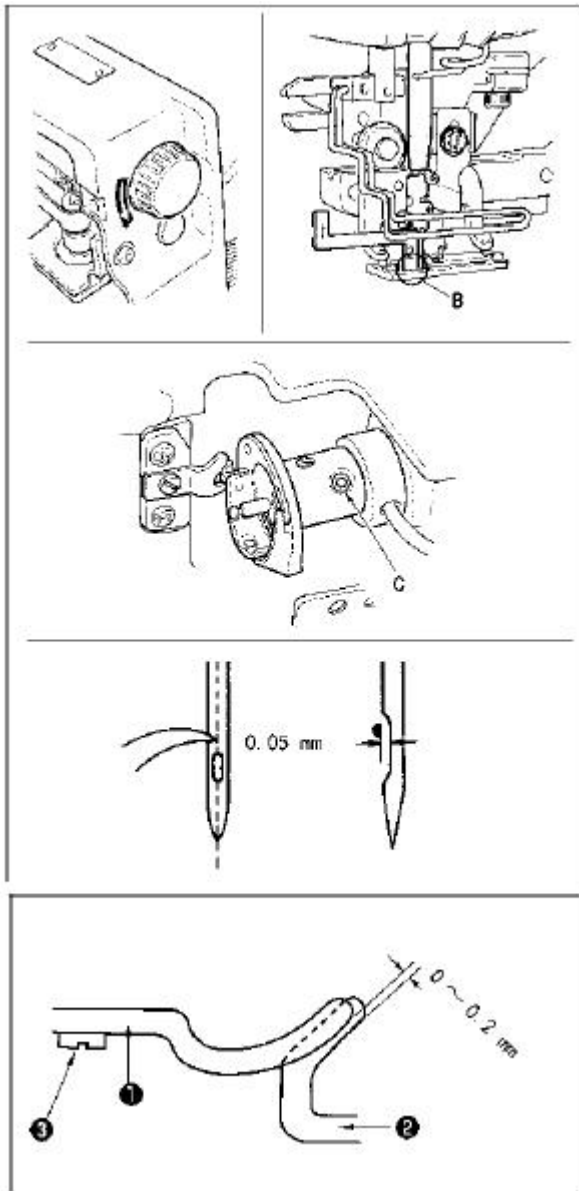

(2) Adjustment of needle-to-hook relation

- 1) Rotate hand driving wheel in accordance with regular rotation direction to lift needle from the lowest point.
- 2) Insert part [2] B of timing gauge into the gap between the bottom end of needle bar and throat plate, where the needle bar touches the timing gauge.
- 3) Loosen setscrew C of the hook sleeve, and align blade point of the sewing hook with the center of needle hole.

Make a clearance of approx. 0.05 mm between the needle and the blade point of the hook.

(3) Adjusting the inner hook stopper

Adjust with setscrew ③ so that the contact of the top end of inner hook stopper ① and the end face of inner hook ② is 0 to 0.2 mm.

## 2. Adjusting the needle thread trimmer

### **! Warning**

Please turn off the power switch and confirm that the motor has stopped before operation to prevent personal injuries caused by unexpected start.

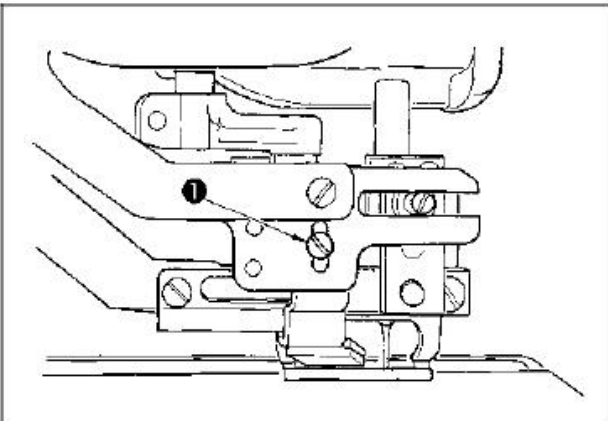
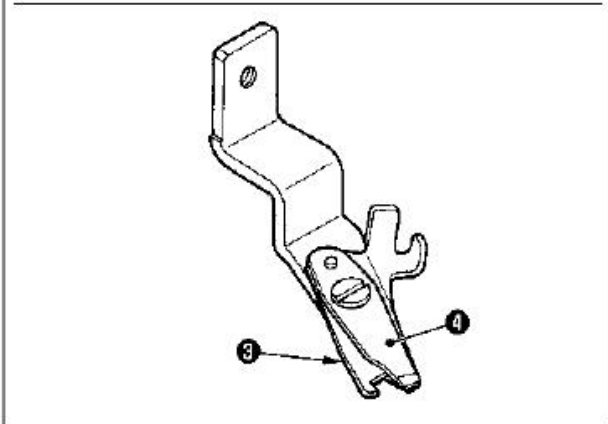
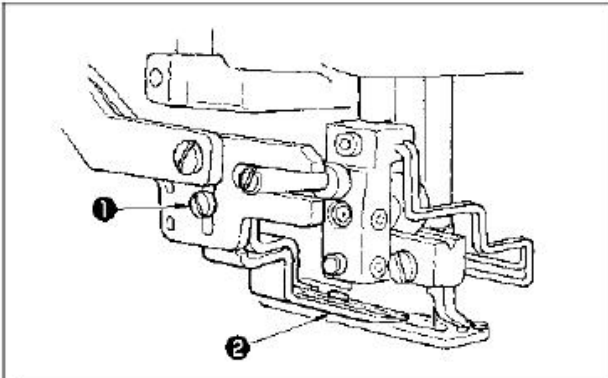

### (1) Adjusting the thread grasping force of the needle thread trimmer

If the needle thread trimmer fails to provide consistent thread grasping force, the needle thread can slip off at the beginning of sewing.

- 1) If the thread grasping force of the needle thread trimmer has reduced, loosen setscrew ① and detach needle thread trimmer ②.
- 2) Slightly bend the top end of thread presser spring and adjust the contact clearance between presser spring ③ and needle thread trimmer ④ to zero.

### (2) Installation height of needle thread trimmer

Loosen setscrew ① of needle thread trimmer and adjust the installation height of needle thread trimmer

Try to make needle thread trimmer do not touch presser as far as possible in order to minimize the length of remaining thread on the needle after trimming.

Note that the presser tilts when sewing a multi-layered portion of the material. Attach the needle thread trimmer to slightly raise the installing position of the trimmer.



When replacing the needle thread trimmer, make sure that the trimmer normally works under the needle thread trimmer adjusting mode (memory switch level 2: K051).

### 3. Adjusting the presser bar pressure

**! Warning** Please turn off the power switch and confirm that the motor has stopped before operation to prevent personal injuries caused by unexpected start.

The presser bar pressure shall be set for each pattern respectively.

#### 1) Set the mode to the input mode

Under the input mode where Set Ready LED <sup>20</sup> goes out, pattern can be changed. In sewing mode,

press Ready key <sup>2</sup>  to change over the mode to input mode.

#### 2) Call S090 presser pressure

Press Edit key <sup>8</sup>  and use Item Selection

key <sup>6</sup>  to select S090 presser pressure A. If S090 value is increased, presser bar pressure will increase and the cloth is difficult to ruffle during sewing.

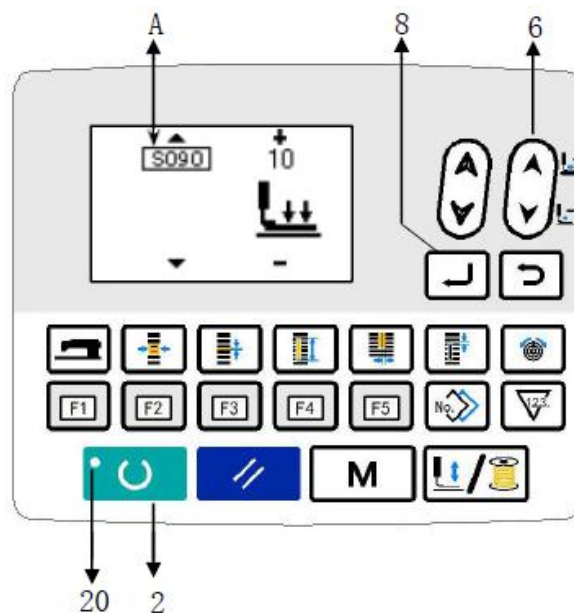

### 4. Adjusting the bobbin presser unit

**! Warning** Please turn off the power switch and confirm that the motor has stopped before operation to prevent personal injuries caused by unexpected start.

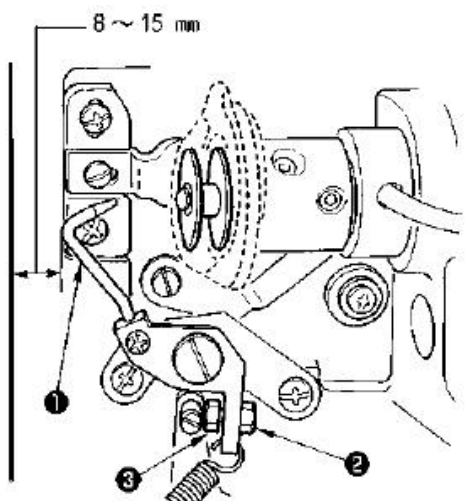

Loosen nut<sup>2</sup> and adjust the position with stopper spring<sup>3</sup> so that the distance from the front end of machine bed to bobbin presser <sup>1</sup> is 8 to 15mm when the sewing machine stops. Then tighten nut<sup>2</sup>.



## 5. Thread tension

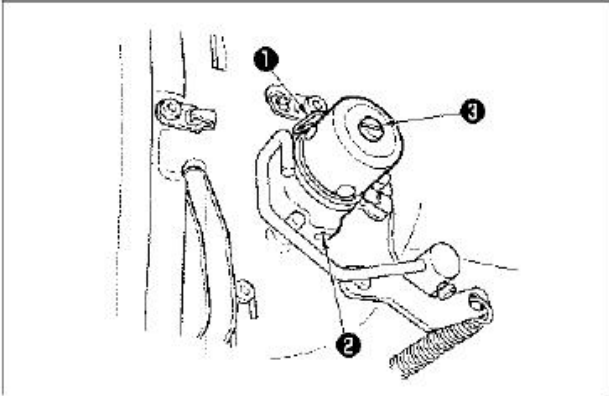

- (1) Thread take-up spring ((purl stitch))
- 1) The thread take-up amount of thread take-up spring① is 8 to 10mm, and the appropriate pressure at the start is approximately 0.06 to 0.1N.
  - 2) To change the stroke of the thread take-up spring, loosen screw②, insert a thin screwdriver into the slot of thread tension post③, and turn it.
  - 3) To change the pressure of the thread take-up spring, insert a thin screwdriver into the slot of thread tension post③ while screw② is tightened, and turn it. Turning it clockwise will increase the pressure of the thread take-up spring. Turning it counterclockwise will decrease the pressure.

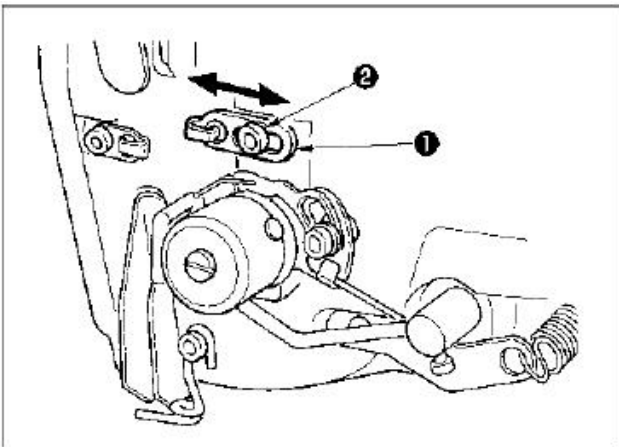

- (2) Adjusting the thread take-up amount of the thread take-up lever
- The thread take-up amount of the thread take-up lever should be adjusted in accordance with the thickness of the sewing products.
- a. For heavy-weight materials, loosen setscrew② in thread guide①, and move the thread guide to the left.
  - b. For light-weight materials, move thread guide① to the right. The thread take-up amount of the thread take-up lever will be reduced.

## 6. Replacing the fuse

### **A Danger**

1. To avoid electrical shock hazards, turn off the power and wait for 5 minutes before opening the cover.
2. Be sure to turn off the power switch before opening the cover of control box and replacing the fuse with specified capacity.

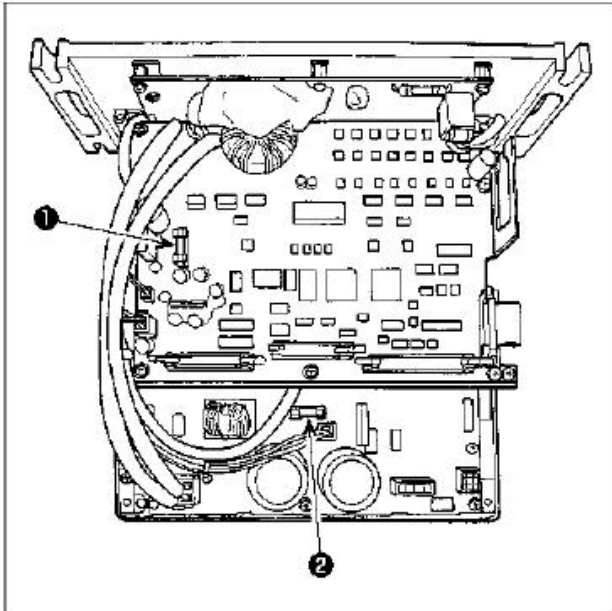

- 1) Turn OFF the power switch after the sewing machine stops.
- 2) Unplug the power cord from power outlet after confirming the power switch turned OFF Then wait for over 5 minutes.
- 3) Remove four screws for fixing rear cover of electric box and then open the rear cover slowly.
- 4) Carefully grasp the glass part of fuse to be replaced and then plug out the fuse.
- 5) Use the fuse with specified capacity.

① FF1 fuse 5 A

DC + 60V for protection

Fuse for protecting pulse motor power and AT relay power

② F2 fuse 2 A

DC + 24V for protection

Fuse for protecting the power of solenoid valve power and sensor, etc.

## VII. Standard Parts

### 1. Cloth cutting knife

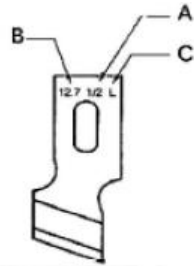

A Knife size (inch)	B Knife size (mm)	C Mark	D Part No.
1/4	6.4	F	CS2702047F
3/8	9.5	K	CS2702047K
7/16	11.1	I	CS2702047I
1/2	12.7	L	CS2702047L
9/16	14.3	V	CS2702047V
5/8	15.9	M	CS2702047M
11/16	17.5	A	CS2702047A
3/4	19.1	N	CS2702047N
7/8	22.2	P	CS2702047P
1	25.4	Q	CS2702047Q
1-1/4	31.8	S	CS2702047S

### 2. Throat plate

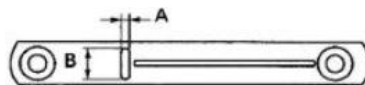

Stitch width	5mm (marking• AxB)	6mm (marking• AxB)
Type		
Standard (S)	CS79004350 ( S5 • 1.4x6.2 )	CS79004351 ( S6 • 1.4x7.4 )
For knits (K)	CS79004352( K5 • 1.2x6.2 )	CS79004353 ( K6 • 1.2x7.4 )

### 3. Presser

#### Stitch width 5mm

Size (AXB)	1 (4x25)	2 (5x35)	3 (5x41)
Type			
Standard (S)	CS01552781	CS01552782	CS01552783
For knits (K)	CS01508771	CS01508772	CS01508773







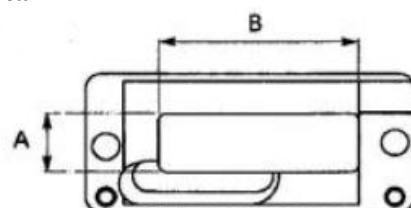











#### Stitch width 6mm



















Size (AXB)	3 (6x41)
Type	
Standard (S)	CS014524409

















Sewing area



























## VIII. List of Error Code

Error code		Description	Reset method	Reset location
E001		<b>EEP-ROM initialization of main control PCB</b> When no data is written into EEP-ROM, or data is damaged, initialization of the data is automatically informed.	Turn OFF the power	
E007		<b>Main shaft motor-lock</b> When large needle resistance sewing product is sewn.	Turn OFF the power	
E011		<b>External media not inserted</b> No external media is inserted	Restart by reset	
E012		<b>Read error</b> Data read from external media cannot be performed.	Restart by reset	Previous screen
E013		<b>Write error</b> Data write from external media cannot be performed.	Restart by reset	Previous screen
E014		<b>Write protection</b> External media is in the write prohibition state.	Restart by reset	Previous screen
E015		<b>Initialization error</b> Initialization of external media cannot be performed.	Restart by reset	Previous screen
E016		<b>Insufficient capacity of external media</b> Capacity of external media is insufficient.	Restart by reset	Previous screen
E017		<b>Insufficient capacity of EEP-ROM</b> Capacity of EEP-ROM is insufficient.	Restart by reset	Previous screen
E018		<b>Wrong type of EEP-ROM</b> When the mounted EEP-ROM is different in type.	Turn OFF the power	Previous screen
E019		<b>Oversized file</b> Size of the file to be read is too large.	Restart by reset	Previous screen
E020		FLASH write error		
E022		<b>File No. error</b> There is no designated file in the server or external media.	Restart by reset	Previous screen
E023		<b>Detection of step-out of presser lifting motor</b> When step-out of motor is detected at the time when presser lifting motor passes origin sensor or starts operation.	Restart by reset	Standard screen
E024		<b>Oversized pattern data</b> When sewing cannot be performed since total size of continuous stitching data or size of downloaded data is too large.	Restart by reset	Standard screen
E025		<b>Detection of step-out of needle thread trimmer motor</b> When step-out of motor is detected at the time when needle thread trimmer motor passes origin sensor or starts operation.	Restart by reset	Standard screen
E026		<b>Detection of step-out of bobbin thread trimmer motor</b> When step-out of motor is detected at the time when bobbin thread trimmer motor passes origin sensor or starts operation.	Restart by reset	Standard screen
E030		<b>Needle bar upper position deviation</b> When needle does not stop at UP position even with needle UP operation at the time of starting sewing machine.	Restart by reset	Standard screen















Error code		Description	Reset method	Reset location
E042		<b>Calculation error</b> Calculation of sewing data cannot be performed.	Restart by reset	Data input screen
E043		<b>Enlargement error</b> Stitching pitch exceeds 5mm.	Restart by reset	Data input screen
E050		<b>Stop switch</b> When stop switch is pressed during machine running.	Restart by reset	Step screen
E052		<b>Thread breakage detection error</b> When thread breakage has occurred during start-up.	Restart by reset	Step screen
E061		<b>Memory switch data error</b> Memory switch data corruption or old version	Turn OFF the power	
E062		<b>Sewing data error</b> Sewing data corruption or old version	Turn OFF the power	
E081		<b>Needle rocking motor out-of-step detection error</b> When the out-of-step of the X needle-rocking motor is detected.	Turn OFF the power	
E082		<b>Feed motor out-of-step detection error</b> When the out-of-step of the Y feed motor is detected.	Turn OFF the power	
E083		<b>Presser foot position error</b> When the presser foot height is excessively high at the time of starting sewing. Adjust K023	Turn OFF the power	
E098		<b>Error caused by insufficient number of stitches required for thread trimming</b>	Re-input by reset	Standard screen
E099		<b>Interference of knife lowering command with thread trimming motion</b> When inserting position of knife command is improper and knife command interferes with thread trimming motion in case of motion by data from external input device.	Restart by reset	Standard screen
E123		No need to upgrade program of control panel		
E124		Control panel is empty and needs to be replaced		
E125		Unmatched upgrade program of control panel		
E126		USB drive unconnected		
E127		Upgrade file not found		
E128		Unmatched machine head memory		
E129		Unmatched machine head type		

E201		X position error		
E202		X shaft overcurrent		
E203		X shaft immovable		
E204		X shaft out of control		
E212		Y shaft overcurrent		
E213		Y shaft immovable		
E214		Y shaft out of control		
E222		Overcurrent of presser foot motor		
E223		Presser foot motor immovable		
E224		Presser foot motor out of control		
E231 E310		Knife motor position error		
E232		knife motor overcurrent		
E233		Knife motor immovable		
E234		Knife motor out of control		
E304		<b>Knife sensor error</b> When the sensor cannot be turned off during knife descending.	Turn OFF the power	
E430	※Count-up screen display (see page 26)	Count-up error	Re-sewing after reset	Standard screen
E452		Machine head memory not connected		

Error code		Description	Reset method	Reset location
E485		<b>Number of times of basting unsetting error</b> When the number of times of basting is not set (OFF) for "Basting+ Cloth cutting knife shape".	Re-input by reset	Sewing data edit screen [S034] Basting stitch (OFF//Number of times) (during continuous sewing) Standard screen
E486		<b>Eyelet knife length error</b> Eyelet knife length is too short to form the shape in case of eyelet shape.	Re-input by reset	Edit sewing data screen [S017] number of times of (OFF/blasting) (during continuous sewing) Standard screen
E487		<b>Eyelet shape error</b> Eyelet shape length is too short to form the shape in case of eyelet shape.	Re-input by reset	(During individual sewing/cycle sewing) Sewing data edit screen [S014] Eyelet shape length (during continuous sewing) Standard screen
E488		<b>Taper bar-tacking compensation error</b> When bar-tacking length is too short to form the shape in case of taper bar-tacking shape.	Re-input by reset	(During individual sewing/cycle sewing) Sewing data edit screen [S008] 2 <sup>nd</sup> bar-tacking length (during continuous sewing) Standard screen
E489		<b>Knife size error (at the time of plural motions of knife)</b> When knife size is larger than cloth cutting knife size.	Re-input by reset	(During individual sewing/cycle sewing) Sewing data edit screen [S002] Cloth cutting length (during continuous sewing) Standard screen
E492		<b>Oversized basting presser</b> When stitching data of basting exceeds presser size.	Re-input by reset	(During individual sewing/cycle sewing) Sewing data edit screen [S040] Basting needle entry compensation (during continuous sewing) Standard screen
E493		<b>Oversized bar-tacking presser at the sewing end</b> When stitching data of tie stitching at sewing end exceeds presser size.	Re-input by reset	(During individual sewing/cycle sewing) Sewing data edit screen [S067] Bar-tacking width at the end of sewing (during continuous sewing) Standard screen
E494		<b>Oversized bar-tacking presser at the start starting</b> When stitching data of tie stitching at sewing start exceeds presser size.	Re-input by reset	(During individual sewing/cycle sewing) Sewing data edit screen [S064] Bar-tacking width at the start of sewing (during continuous sewing) Standard screen
E495		<b>Presser size error (Width direction: right only)</b> When stitching data exceeds the size of right only of width direction of presser.	Re-input by reset	(During individual sewing/cycle sewing) Sewing data edit screen [S003] Right knife groove width or [S006] ratio of right and left shapes (during continuous sewing) Standard screen
E496		<b>Presser size error (width direction: left only)</b> When stitching data exceeds the size of left only of width direction of presser.	Re-input by reset	(During individual sewing/cycle sewing) Sewing data edit screen [S004] Left knife groove width or [S006] ratio of right and left shapes (during continuous sewing) Standard screen
E497		<b>Presser size error (length direction: front)</b> When stitching data exceeds the size of front of length direction of presser.	Re-input by reset	Standard screen

Error code		Description	Reset method	Reset location
E498		<b>Presser size error (Width direction: right and left)</b> When stitching data exceeds the size of both right and left of width direction of presser.	Re-input by reset	(During individual sewing/cycle sewing) Sewing data edit screen [S005]Left overedging width (during continuous sewing) Standard screen
E499		<b>Presser size error (length direction: rear)</b> When stitching data exceeds the size of rear of length direction of presser.	Re-input by reset	(During individual sewing/cycle sewing) Sewing data edit screen [S002] Cloth cutting length (during continuous sewing) Standard screen
E703		<b>Panel is connected to the machine other than supposed (machine type error)</b> When machine type code of system is improper in case of initial communication.	Turn OFF the power	
E704		<b>Wrong system version</b> When version of system software is improper in case of initial communication.	Turn OFF the power	
E730		<b>Main shaft motor encoder defectiveness or phase-lack</b> When encoder of sewing machine motor is abnormal.	Turn OFF the power	
E731		<b>Main motor hole sensor defectiveness or position sensor defectiveness</b> When hole sensor or position sensor of sewing machine motor is defective.	Turn OFF the power	
E733		<b>Reverse rotation of main shaft motor</b> When sewing machine motor rotates in reverse direction.	Turn OFF the power	
E801		<b>Phase-lack of power</b> When phase-lack of input power occurs.	Turn OFF the power	
E802		<b>Momentary power failure detected</b> When input power is instantaneously OFF.	Turn OFF the power	
E811		<b>Over voltage</b> When input power source voltage is equal to or more than the specified value.	Turn OFF the power	
E813		<b>Under voltage</b> When input power source voltage is less than the specified value.	Turn OFF the power	
E901		<b>Abnormality of main shaft motor IPM</b> When IPM of servo control PCB is abnormal.	Turn OFF the power	
E902		<b>Overcurrent of main shaft motor</b> When current flows excessively to sewing machine motor.	Turn OFF the power	
E903		<b>Abnormality of stepping motor power</b> When the stepping motor power of the servo-control PCB is out of the range of the specified values.	Turn OFF the power	



Error code		Description	Reset method	Reset location
E904		<b>Abnormality of solenoid power</b> When the solenoid power of the servo-control PCB is out of the range of the specified values.	Turn OFF the power	
E905		<b>Abnormality of temperature of heat sink for servo control PCB</b> When temperature of heat sink of servo control PCB is 85°C or more.	Turn OFF the power	
E906		<b>Abnormality of temperature of heat-dissipating metal plate of main circuit board</b> In case of abnormal high temperature of heat-dissipating metal plate of main circuit board.	Turn OFF the power	
E907		<b>Needle rocking motor origin retrieval error</b> When origin sensor signal is not input at the time of origin retrieval motion.	Turn OFF the power	
E908		<b>Y feed motor origin retrieval error</b> When origin sensor signal is not input at the time of origin retrieval motion.	Turn OFF the power	
E909		<b>Needle thread trimmer motor origin retrieval error</b> When origin sensor signal is not input at the time of origin retrieval motion.	Turn OFF the power	
E910		<b>Presser motor origin retrieval error</b> When origin sensor signal is not input at the time of origin retrieval motion.	Turn OFF the power	
E911		<b>Bobbin thread trimmer motor origin retrieval error</b> When origin sensor signal is not input at the time of origin retrieval motion.	Turn OFF the power	
E912	—	<b>Sewing motor speed detection error</b> When the sewing machine motor malfunctions	Turn OFF the power	
E915		<b>Abnormality of communication between operation panel and main CPU</b> When abnormality occurs in communication.	Turn OFF the power	
E916		<b>Abnormality of communication between main CPU and main shaft CPU</b> When abnormality occurs in communication.	Turn OFF the power	
E918		<b>Abnormality of temperature of heat sink for main control PCB</b> When temperature of heat sink of main control PCB is 85°C or more.	Turn OFF the power	
E943		<b>Defectiveness of EEP-ROM of main control PCB</b> When data writing to EEP-ROM is not performed.	Turn OFF the power	
E946		<b>Defectiveness of writing to EEP-ROM of head relay PCB</b> When data writing to EEP-ROM is not performed.	Turn OFF the power	
E998		<b>Presser deviation error</b> In the case the presser foot fails to go up when the pedal is released or when the sewing is finished. Turn the power OFF. Check whether the work clamp can be lifted/lowered manually. At this moment, do not touch the needle or the knife.	Turn OFF the power	
E999		<b>Cloth cutting knife does not return</b> <ul style="list-style-type: none"> <li>When cloth cutting knife does not return after the lapse of predetermined time.</li> <li>When sensor is not turned ON while cloth cutting knife is raising (at the time of waiting).</li> </ul>	Turn OFF the power	

## IX. Trouble and Corrective Measures

Troubles	Causes	Corrective measures	Page
1. Needle thread breakage	<ol style="list-style-type: none"> <li>1. Thread tension at parallel section is too high.</li> <li>2. Thread take-up spring tension is too strong and stroke is too large.</li> <li>3. There is a burr or scratch on the blade point of hook.</li> <li>4. Hook timing is not proper.</li> <li>5. There is a scratch on the thread path.</li> <li>6. Attaching needle is wrong.</li> <li>7. Needle is too thin.</li> <li>8. Needle tip is damaged.</li> <li>9. Thread breaks when it is bent</li> </ol>	<ul style="list-style-type: none"> <li>○ Decrease the thread tension at parallel section.</li> <li>○ Decrease the tension of the thread take-up spring or decrease its stroke.</li> <li>○ Buff the blade point of hook, or replace the hook.</li> <li>○ Adjust the timing of hook by use of synchronous ruler.</li> <li>○ Polish the thread path with sand paper and buff it.</li> <li>○ Adjust again the direction, height, etc.</li> <li>○ Replace the needle with a thicker one.</li> <li>○ Replace the needle.</li> <li>○ Do not pass the thread through the thread guide pin.</li> </ul>	<p>25</p> <p>64</p> <p>—</p> <p>61</p> <p>—</p> <p>14</p> <p>—</p> <p>—</p> <p>12</p>
2. Needle thread slips off	<ol style="list-style-type: none"> <li>1. Needle thread trimmer opens too early.</li> <li>2. Whip stitching is not formed at the start of sewing. (Tension at the start of sewing is too high.)</li> <li>3. Threading needle thread is wrong.</li> <li>4. Speed at the start of sewing is too fast.</li> </ol>	<ul style="list-style-type: none"> <li>○ Needle thread clamp opens too late during needle thread cutting.</li> <li>○ Decrease tension at the start of sewing.</li> <li>○ Thread properly again.</li> <li>○ Set the soft-start function.</li> </ul>	<p>62</p> <p>36</p> <p>15</p> <p>52</p>
3. Wobbling at parallel section	<ol style="list-style-type: none"> <li>1. Decrease the thread tension at parallel section.</li> <li>2. Bobbin thread tension is too high.</li> <li>3. Tension is too low.</li> </ol>	<ul style="list-style-type: none"> <li>○ Increase the thread tension at parallel section.</li> <li>○ Decrease tension of the bobbin thread. (Purl stitch: 0.05 to 0.1N)</li> <li>○ Increase the tension.</li> </ul>	<p>25</p> <p>16</p> <p>—</p>
4. Wobbling at the start of sewing	<ol style="list-style-type: none"> <li>1. Decrease the thread tension at parallel section.</li> <li>2. Position of needle thread trimmer is too high.</li> <li>3. Stroke of thread take-up spring is too large.</li> </ol>	<ul style="list-style-type: none"> <li>○ Increase the thread tension at parallel section.</li> <li>○ Lower the needle thread trimmer to such an extent that it does not come in contact with the presser.</li> <li>○ Decrease the stroke of thread take-up spring.</li> </ul>	<p>25</p> <p>62</p> <p>64</p>
5. Needle thread appears on the wrong side of material at bar-tacking section in dumpling condition.	<ol style="list-style-type: none"> <li>1. Bar-tacking thread tension is too low.</li> <li>2. Bobbin thread tension is too high.</li> <li>3. Number of stitches is large due to radial shape</li> <li>4. Tension at the end of sewing is too low.</li> </ol>	<ul style="list-style-type: none"> <li>○ Increase the bar-tacking thread tension.</li> <li>○ Decrease tension of the bobbin thread. (0.05 to 0.1N)</li> <li>○ Decrease the number of stitches.</li> <li>○ Increase tension at the end of sewing.</li> </ul>	<p>25</p> <p>16</p> <p>34</p> <p>52</p>
6. Stitches float.	<ol style="list-style-type: none"> <li>1. Bobbin thread tension is too high.</li> <li>2. Bobbin thread comes off bobbin case</li> </ol>	<ul style="list-style-type: none"> <li>○ Increase the bobbin thread tension.</li> <li>○ Perform proper threading the bobbin case.</li> <li>○ Take care that the winding amount of bobbin thread is not excessive.</li> </ul>	<p>16</p> <p>15</p> <p>27</p>
7. Stitch skipping	<ol style="list-style-type: none"> <li>1. Button hole is small in terms of the size of presser.</li> <li>2. Material flops because of light-weight.</li> <li>3. Attaching needle is wrong.</li> <li>4. Needle is bent.</li> <li>5. There is a burr or scratch on the blade point of hook.</li> </ol>	<ul style="list-style-type: none"> <li>○ Replace the presser with a smaller one.</li> <li>○ Delay the hook-to-needle timing. (Lower the needle bar by 0.5mm)</li> <li>○ Adjust again the direction, height, etc.</li> <li>○ Replace the needle.</li> <li>○ Buff the blade top of hook. Or, replace the hook.</li> </ul>	<p>—</p> <p>61</p> <p>14</p> <p>—</p> <p>—</p>
8. Thread frays.	<ol style="list-style-type: none"> <li>1. Number of stitches of the stitching is too small.</li> <li>2. Width of tie stitching is too wide.</li> </ol>	<ul style="list-style-type: none"> <li>○ Increase the number of stitches of tie stitching at the end of sewing.</li> <li>○ Narrow the width of tie stitching at the end of sewing.</li> </ul>	<p>37</p> <p>37</p>
9. Length of needle thread remaining at the end of sewing is too long.	<ol style="list-style-type: none"> <li>1. Width of tie stitching is too narrow.</li> <li>2. Tension of tie stitching is too low.</li> </ol>	<ul style="list-style-type: none"> <li>○ Widen the width of tie stitching at the end of sewing.</li> <li>○ Increase the tension at the end of sewing.</li> </ul>	<p>37</p> <p>52</p>

Troubles	Causes	Corrective measures	Page
10. Needle thread breaks at the start of sewing, or the wrong side of seam is dirty.	1. Tension at the start of sewing is too low.	○ Increase tension at the start of sewing.	36
11. The knife does not descend after cutting needle thread.	1. Check whether the thread breakage detector plate is properly adjusted.	○ Adjust the detector plate. (Refer to the Service Manual.)	—
12. Needle breaks	1. Check whether needle is bent. 2. Check whether needle comes in contact with the blade point of hook. 3. Check whether needle thread trimmer comes in contact with needle when it opens. 4. Check whether needle comes in the center of the needle hole of throat plate. 5. Check whether needle stop position is too low and needle comes in contact with needle thread trimmer when it closes.	○ Replace the needle. ○ Adjust the needle-to-hook timing. ○ Adjusting the installation position of the needle thread trimmer. ○ Adjust again the installation position of the needle plate seat.	14 61 62 —
13. Dropping times of the knife	1. Check whether the cloth cutting knife dropping is set to plural dropping.	○ Release the plural time setting.	50



# GT1790A

## COMPUTER-CONTROLLED HIGH SPEED LOCKSTITCH BUTTONHOLING MACHINE



This machine may only be operated by adequately trained operators only after having completely read and understood the instruction manual.

Parts are subject to changes in design without prior notice.

### **XI'AN TYPICAL INDUSTRIES CO., LTD.**

No. 335, South Taibai Road  
Xi'an 710068, P.R.China  
Tel.: +86-29-88279093 // 88279150 //  
88279151  
Fax: +86-29-88249715 // 88245215

E-mail: [tic@chinatypical.com](mailto:tic@chinatypical.com)  
[www.chinatypical.com](http://www.chinatypical.com)



Certificate of the  
international  
ISO9001



Certificate of the  
ISO14001



Certificate of the  
international CE



Certificate for  
Ecotabelling  
Product



Certificate for  
Energy  
Conservation

### **Vetron Typical Europe GmbH**

Clara-Immerwahr-Str. 6  
67661 Kaiserslautern, Germany  
Tel. +49 6301 320 75-0  
Fax +49 6301 320 75-11

[info@vetrontypical.com](mailto:info@vetrontypical.com)  
[www.vetrontypical.com](http://www.vetrontypical.com)